



31212

3





Our Solar System and Earth

YOU ARE HERE. Earth is a rare gem in our solar system and the known universe. Our lush and vibrant home planet peacefully coexists with the three other terrestrial planets, Mars, Venus and Mercury, gas giants Saturn and Jupiter and ice giants Uranus and Neptune. Only a century ago, it was estimated that the universe consisted of around 2,000 stars. In the past few decades alone, space missions have revealed a seemingly infinite number of galaxies in an ever-expanding universe.

Scan the QR code
to listen to chapter 2 in
the exclusive LEGO® Art
Milky Way soundtrack.



TRAPPIST-1

The TRAPPIST-1 system, 40 light years from the Sun, is a red dwarf star, roughly the size of Jupiter, orbited by seven Earth-sized exoplanets. Most of the planets are within the 'Goldilocks Zone' (habitable zone) and could have water vapour, running water or ice on the surface. About 8% less dense than Earth, the planets are most likely composed of various ratios of iron, oxygen, magnesium and silicon.



The Pleiades

Messier 45, The Seven Sisters, The Pleiades. By any name, this open star cluster is one of the nearest to Earth. At about 445 light years away, it consists of more than a thousand loosely connected stars. You don't even need a telescope to see them, as some of the biggest and brightest stars are visible in the Taurus constellation – most clearly in January. Observations of the cluster have been recorded for millennia, and it may have played a role in maritime navigation in ancient times.



The Crab Nebula

The Crab Nebula is the aftermath of a supernova, documented by astronomers in 1054 as a star so bright it could be seen during the day over a period of several months. In fact, the explosion 6,500 light years away would have briefly emitted light equivalent to 400 million suns. The Crab Nebula, now around 10 light years across, rotates about 30 times per second, with a dense neutron star at the centre forming an immense magnetic field and radiation.



The Pillars of Creation

First discovered in 1920, 'only' around 5,700 light years from Earth in the Eagle Nebula, this star 'nursery' region has fascinated the world in recent decades, following publications of striking composite images from advanced space telescopes. Based on the detection of X-ray sources emitted from the region, it is estimated that hundreds of new stars are forming here; one in particular seems to contain four or five times the mass of our Sun.



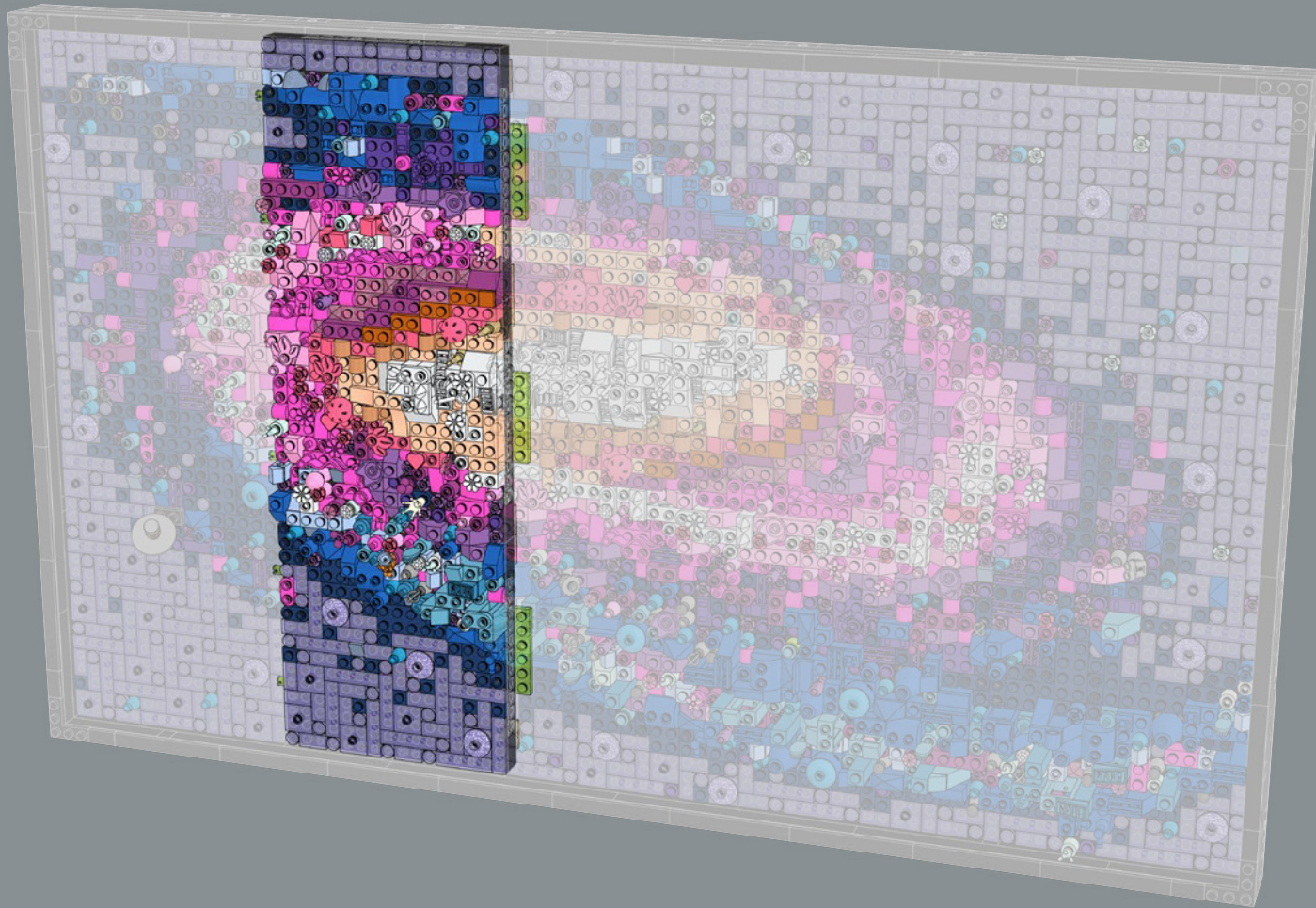

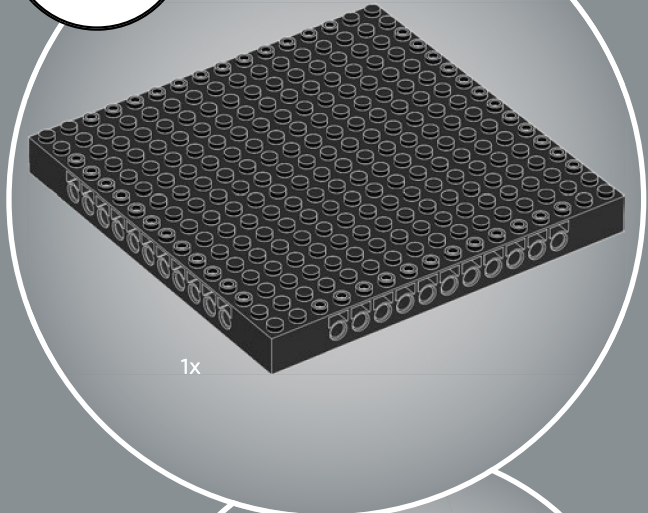
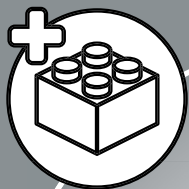

1x

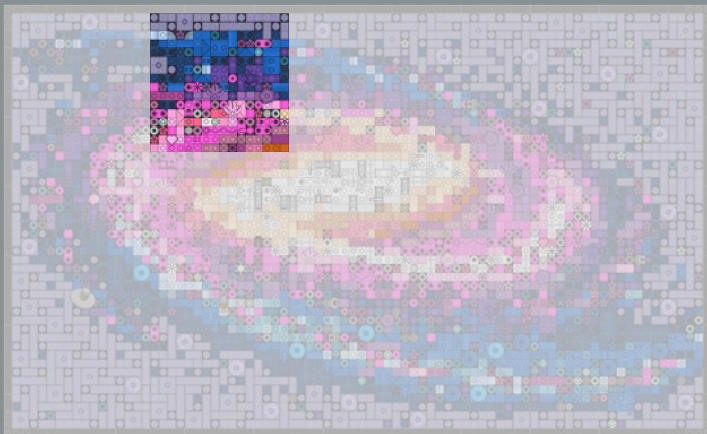

2x

1

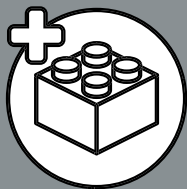
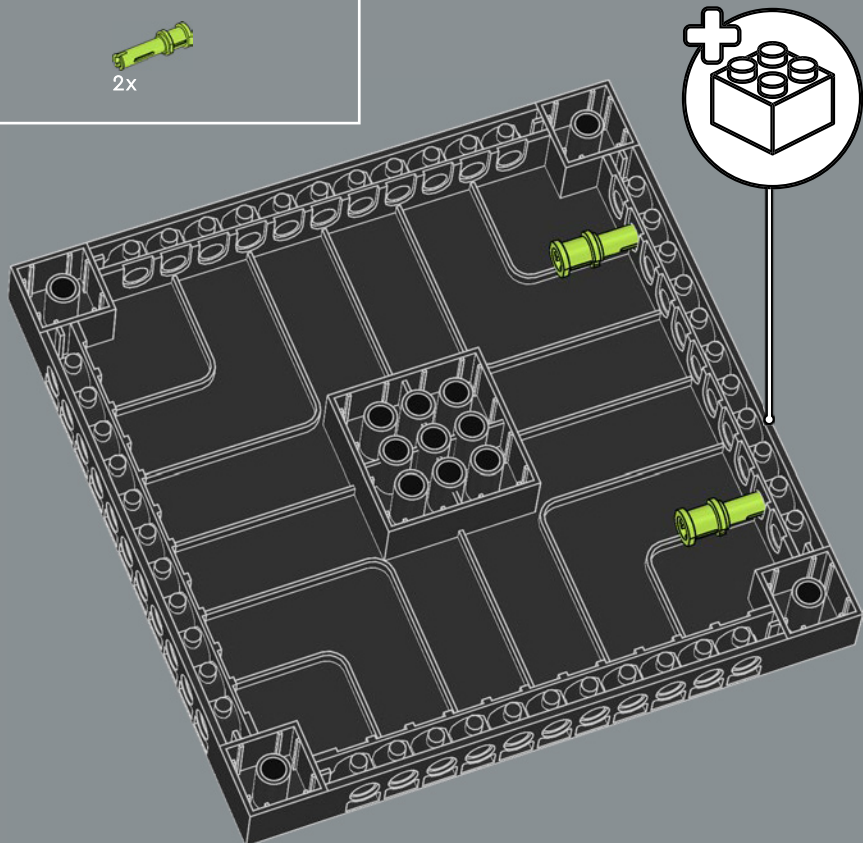

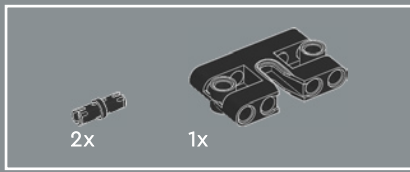

2

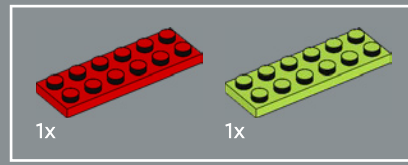
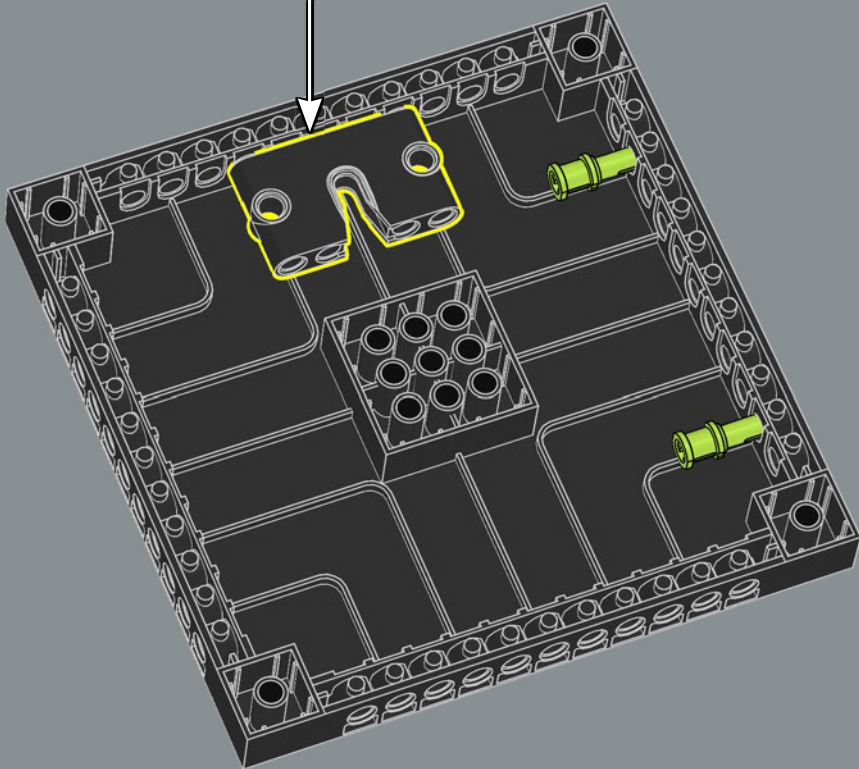
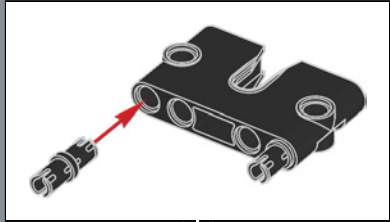

3

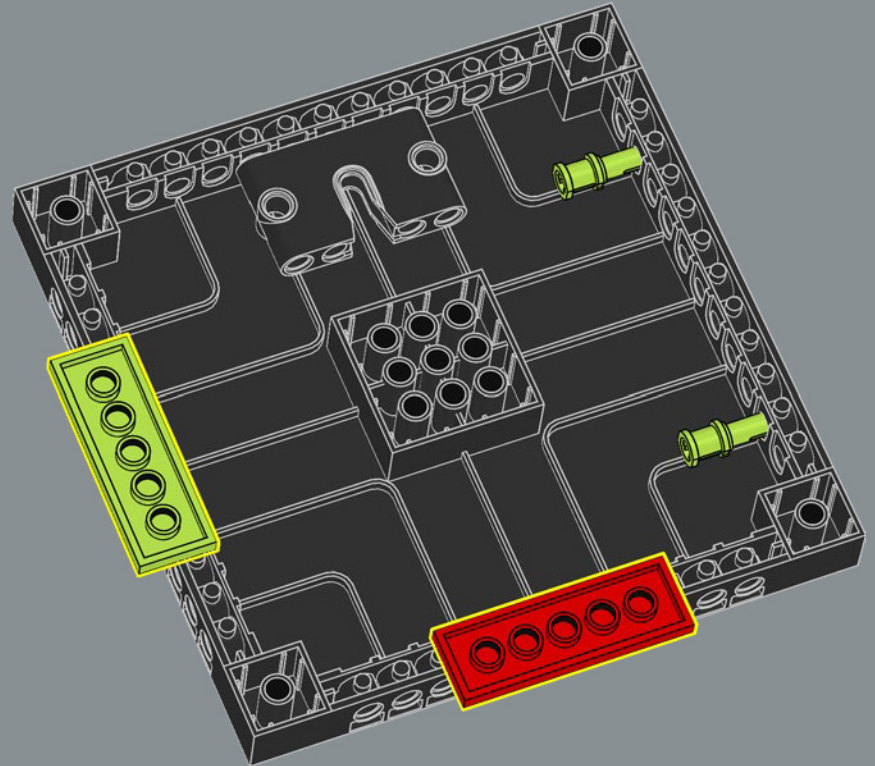

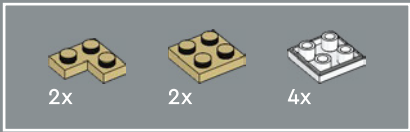

4

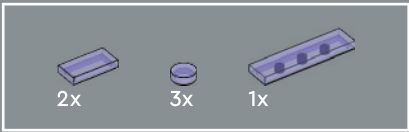
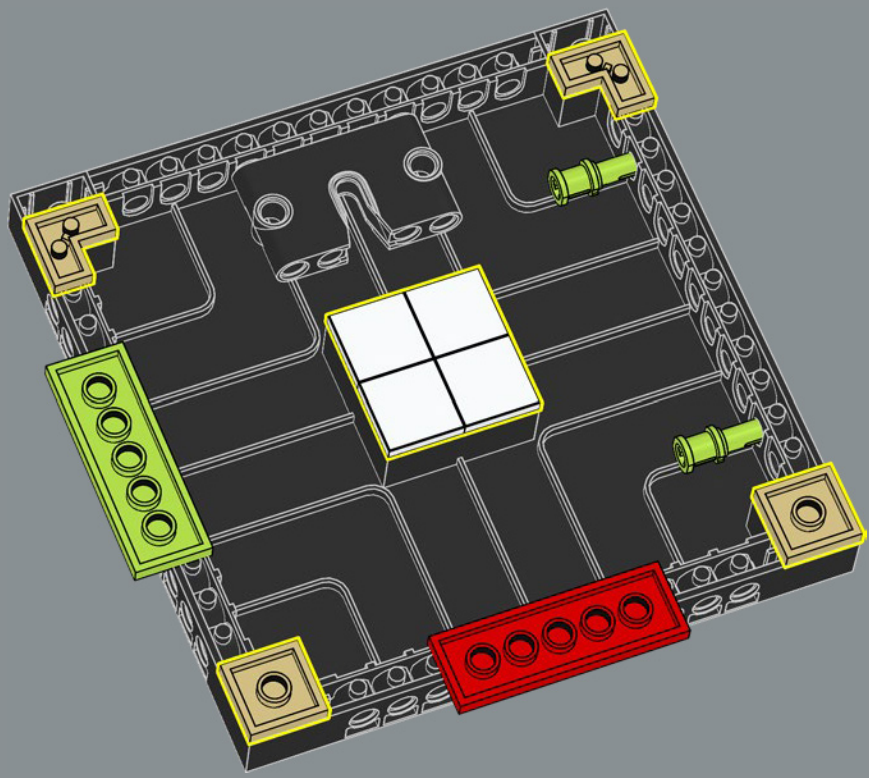

5

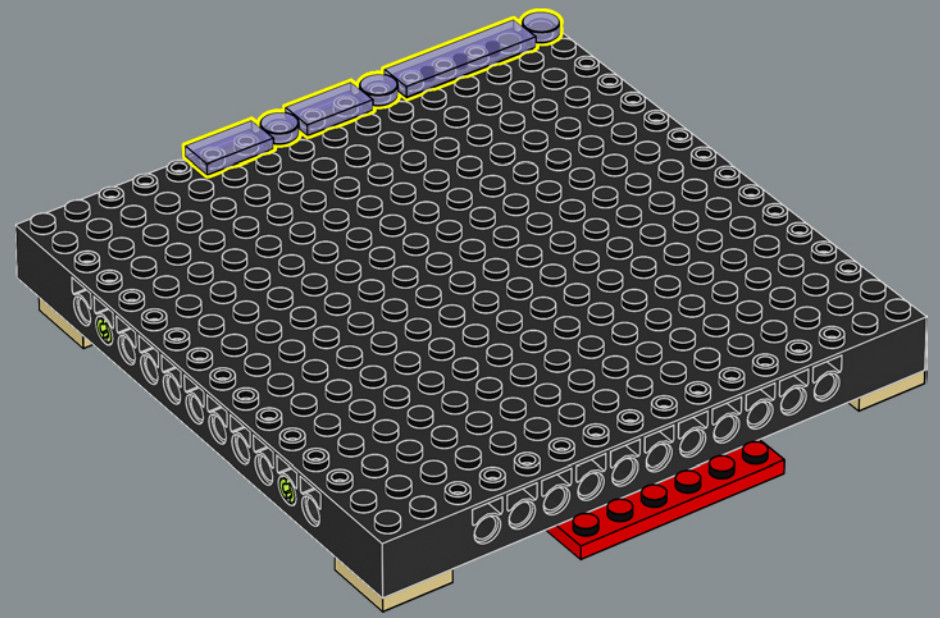

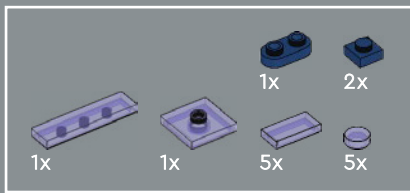

6

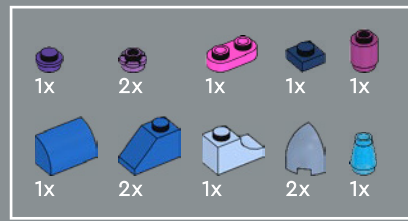
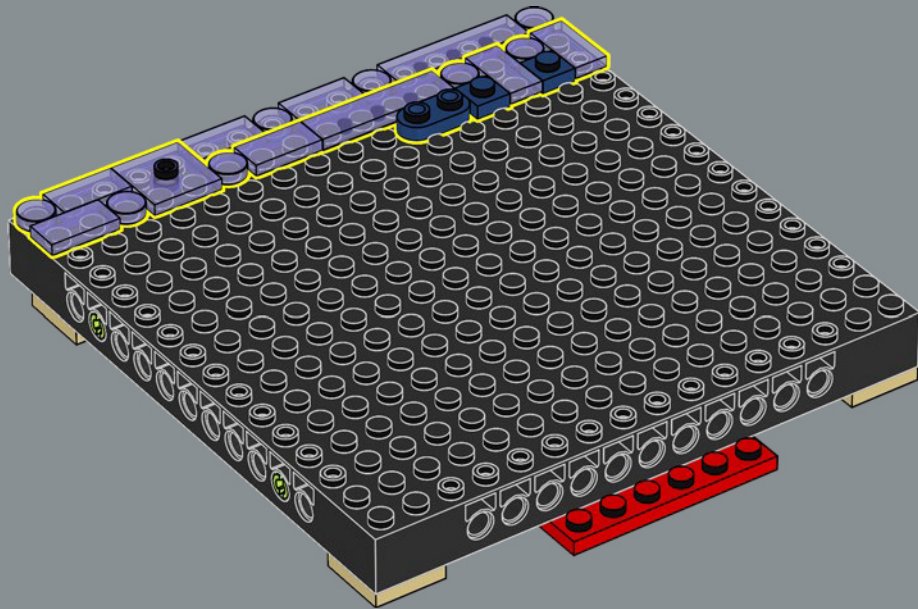

7

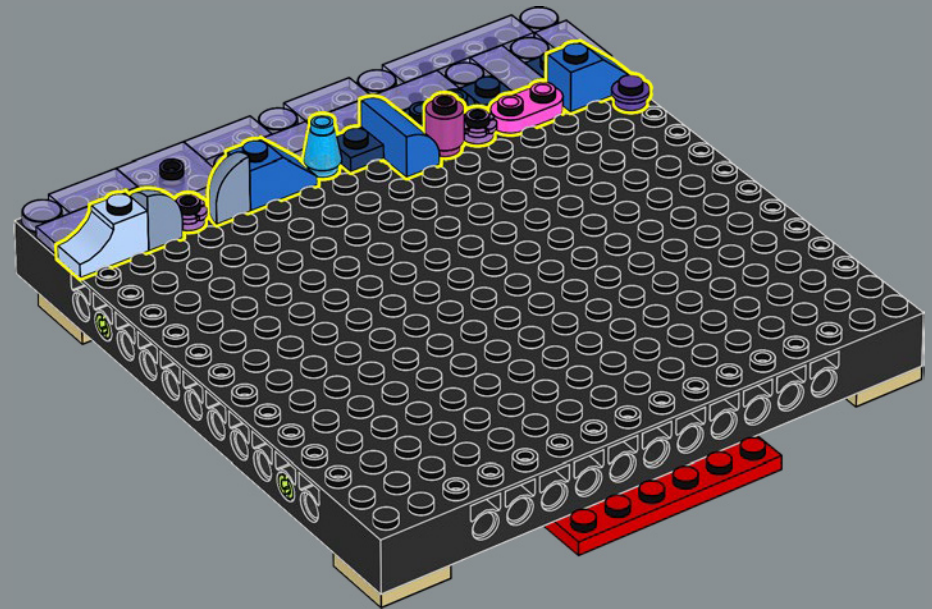

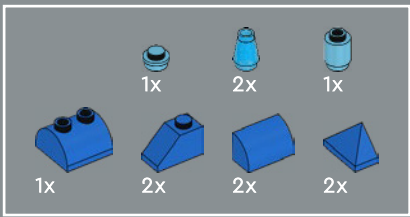

8

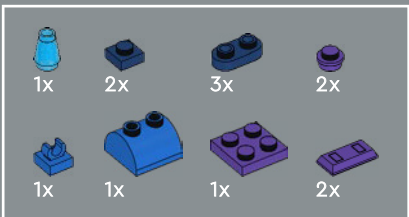
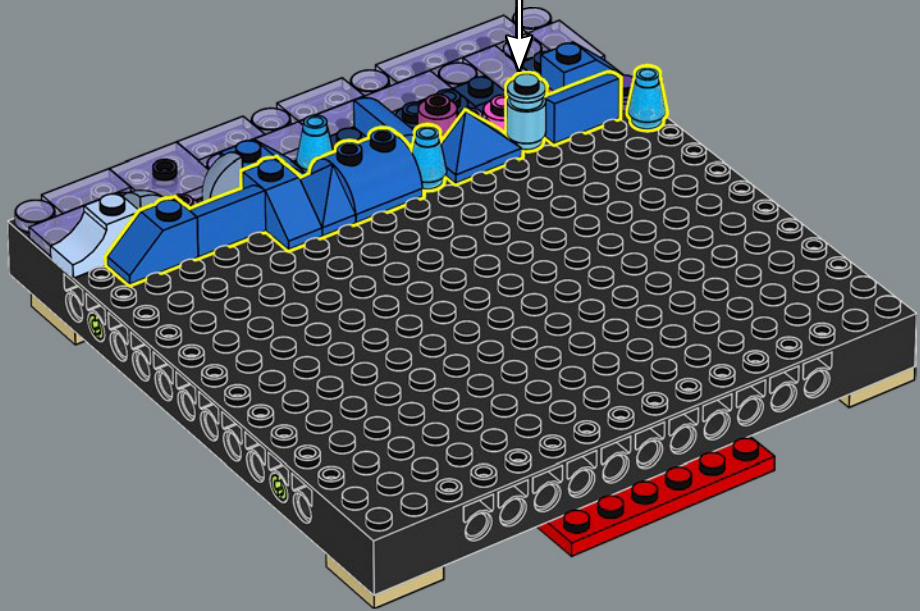
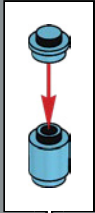

9

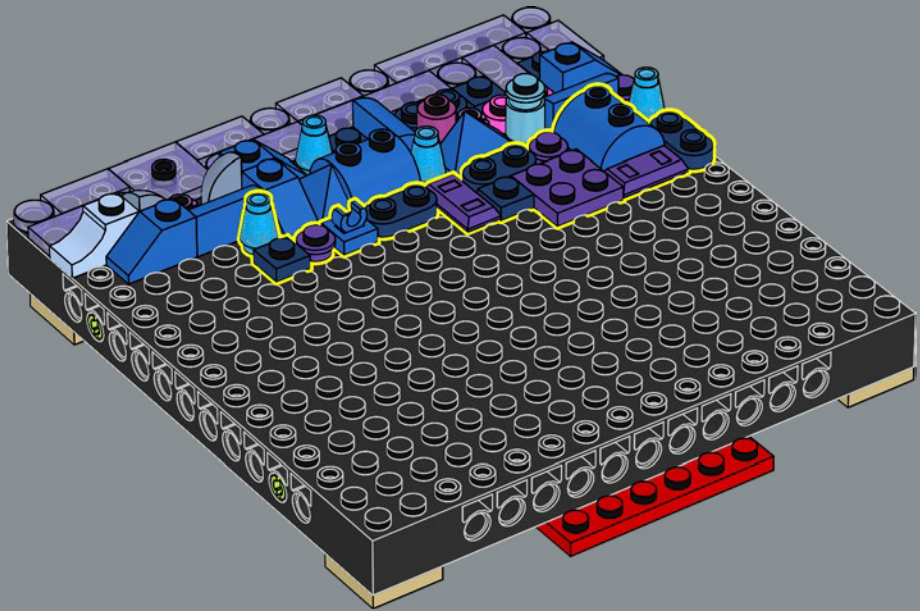

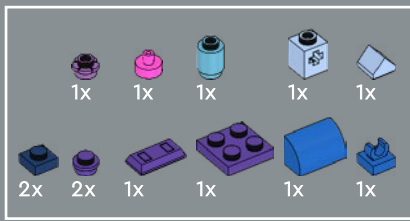

10

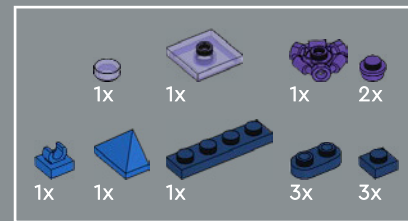
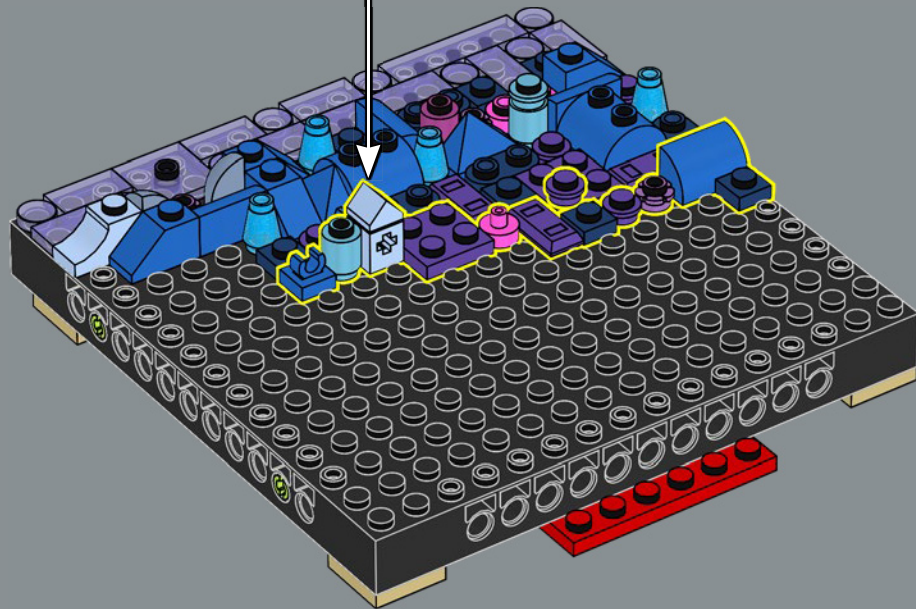
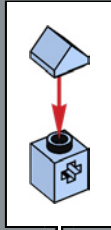

11

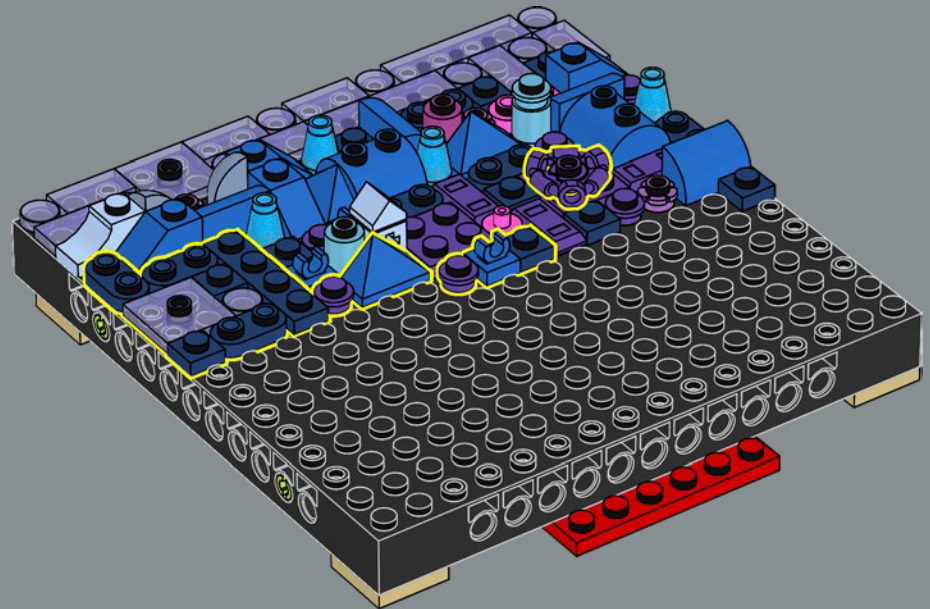

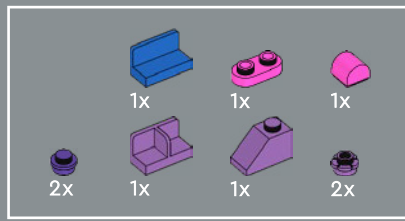

12

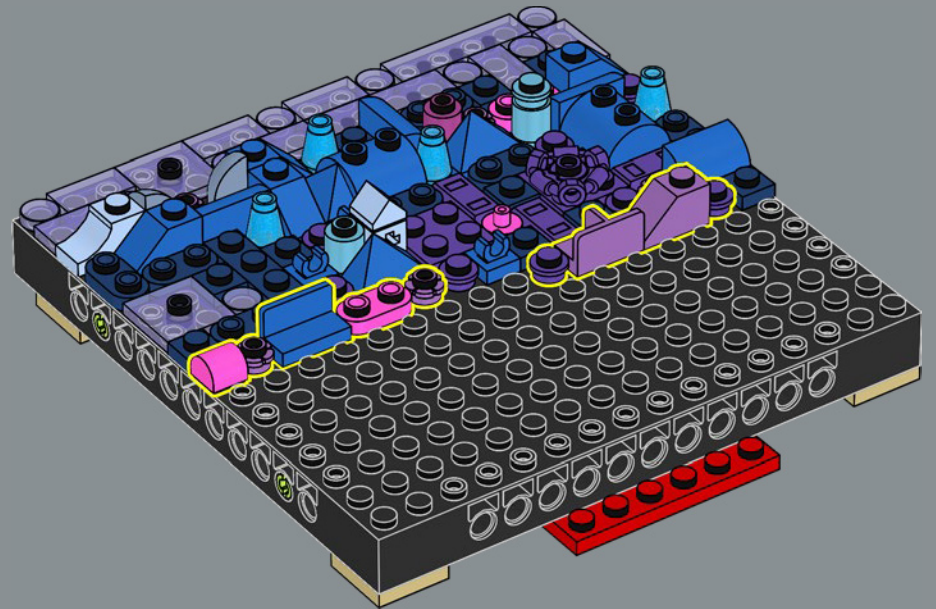

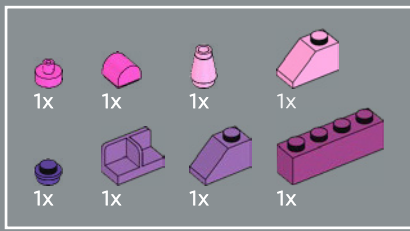

13

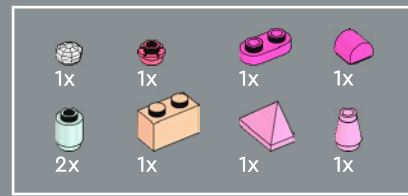
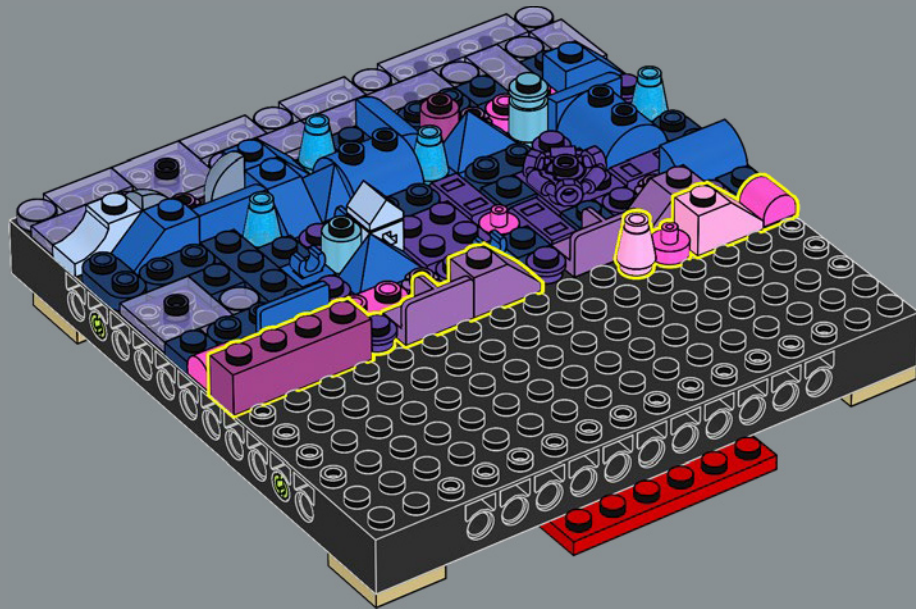

14

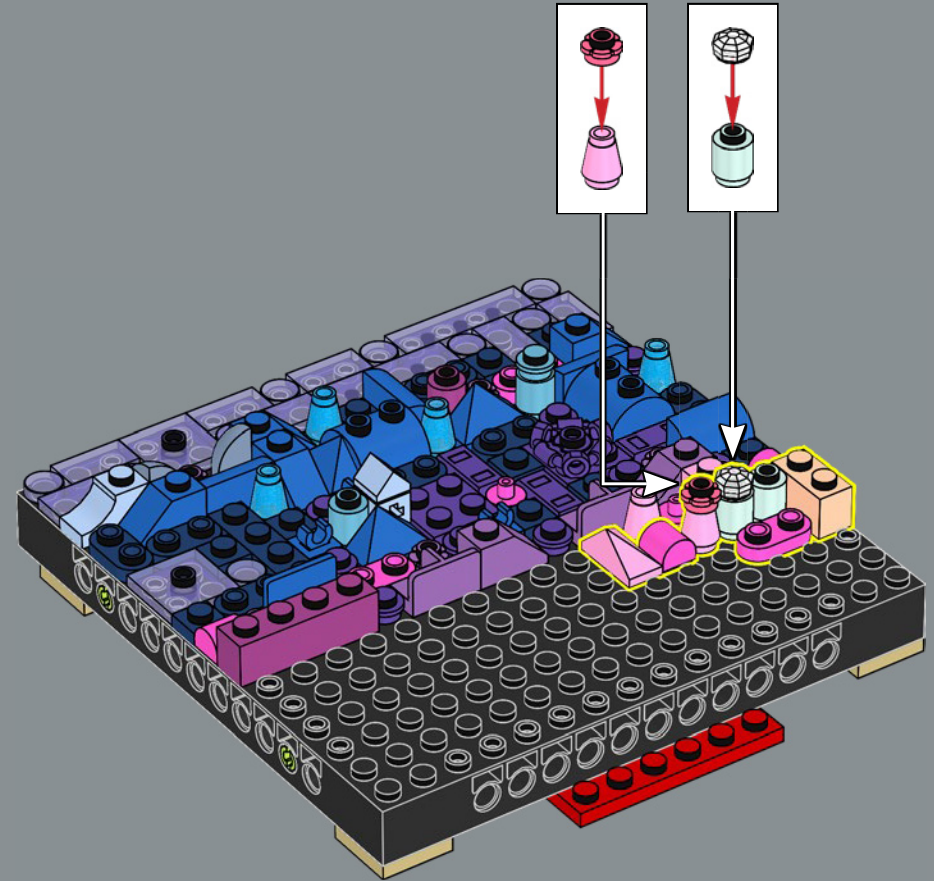

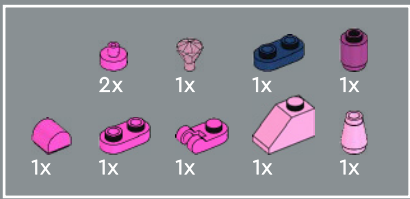

15

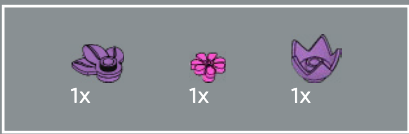
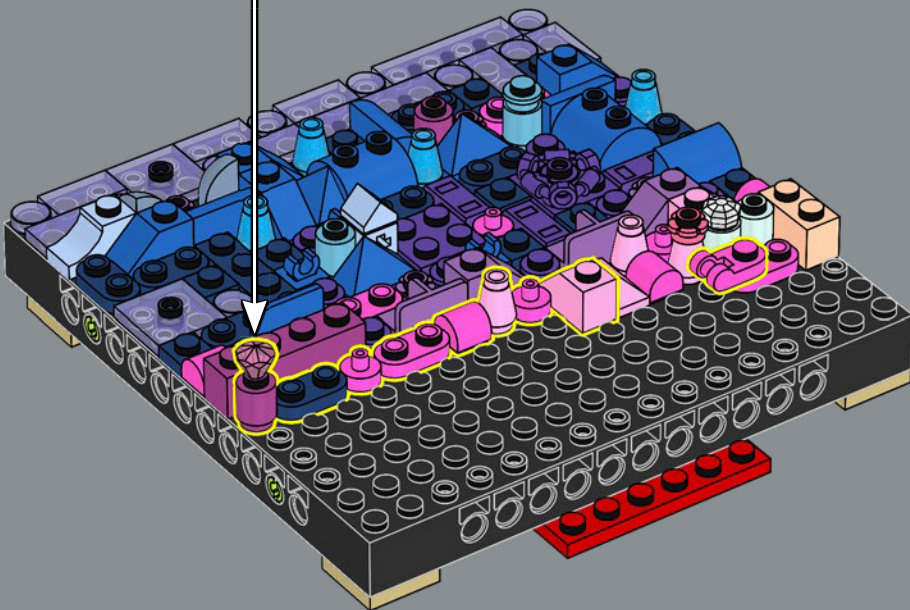
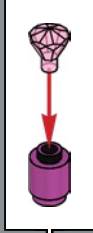

16

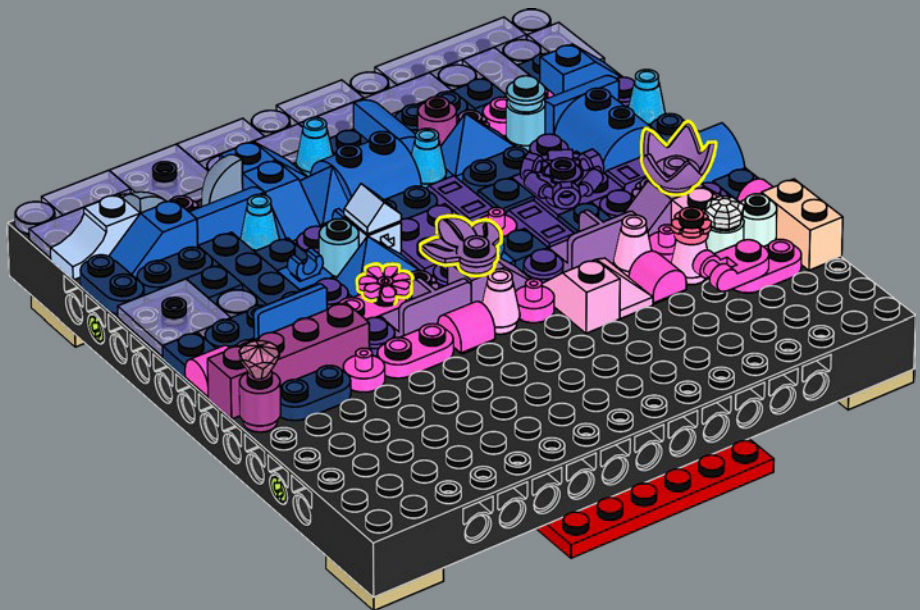



17

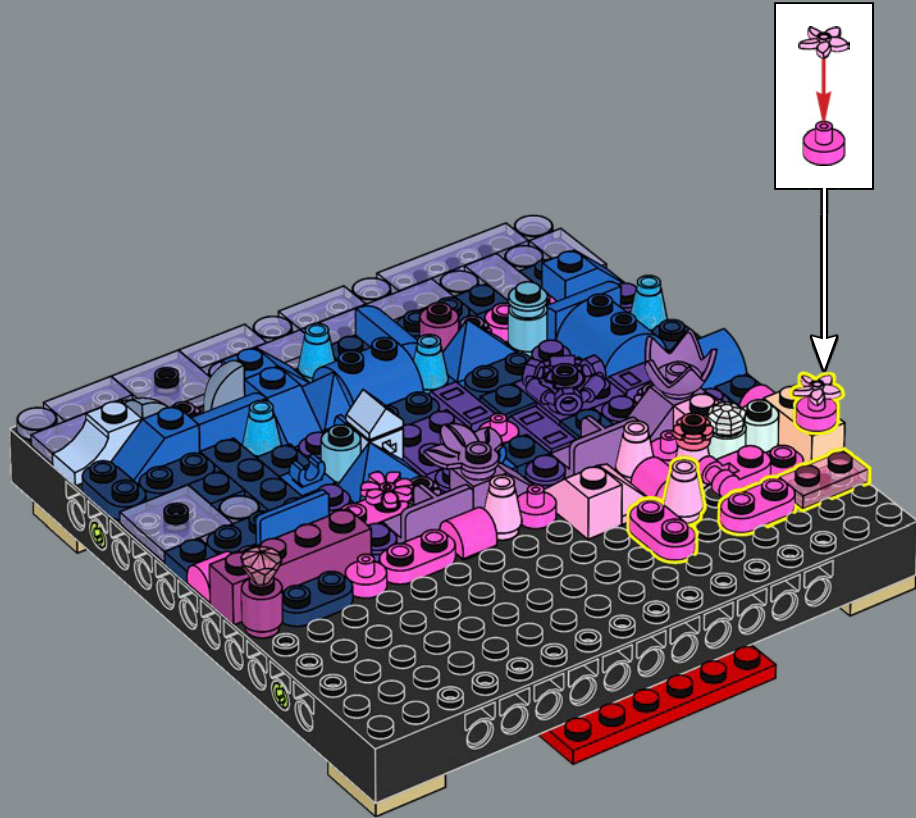

18

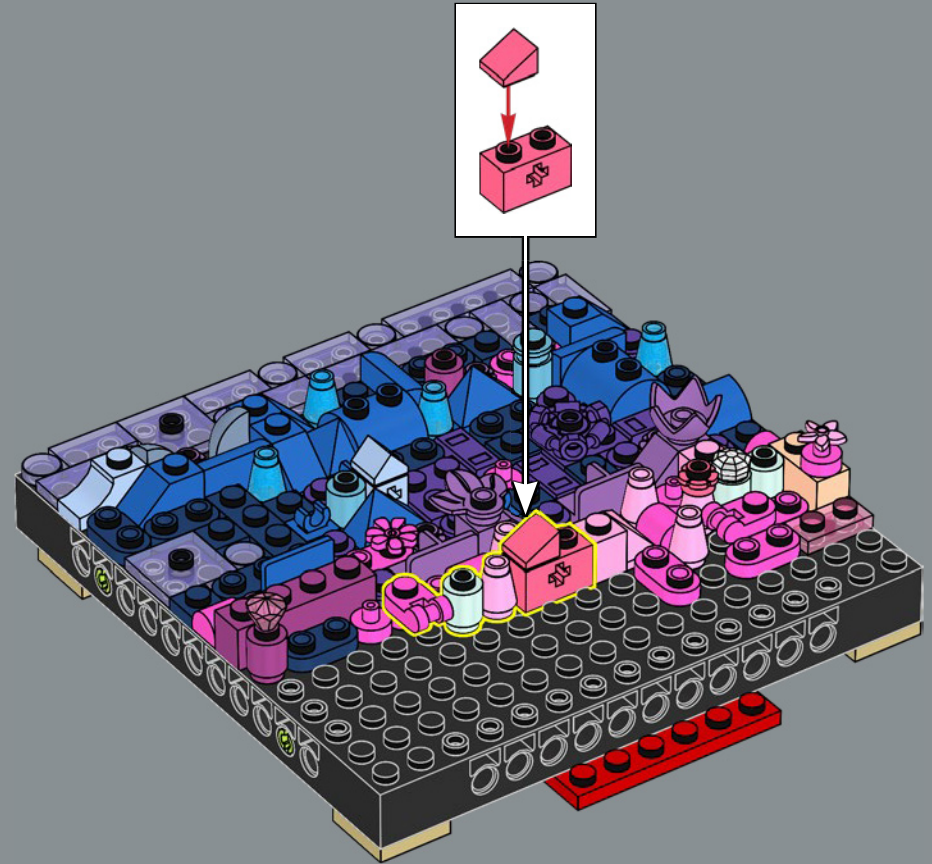

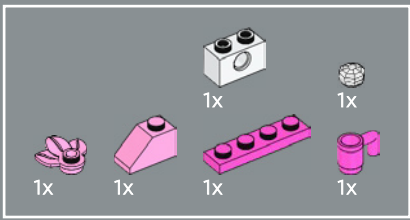

19

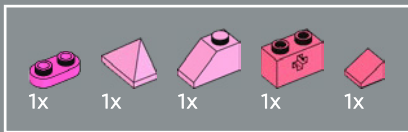
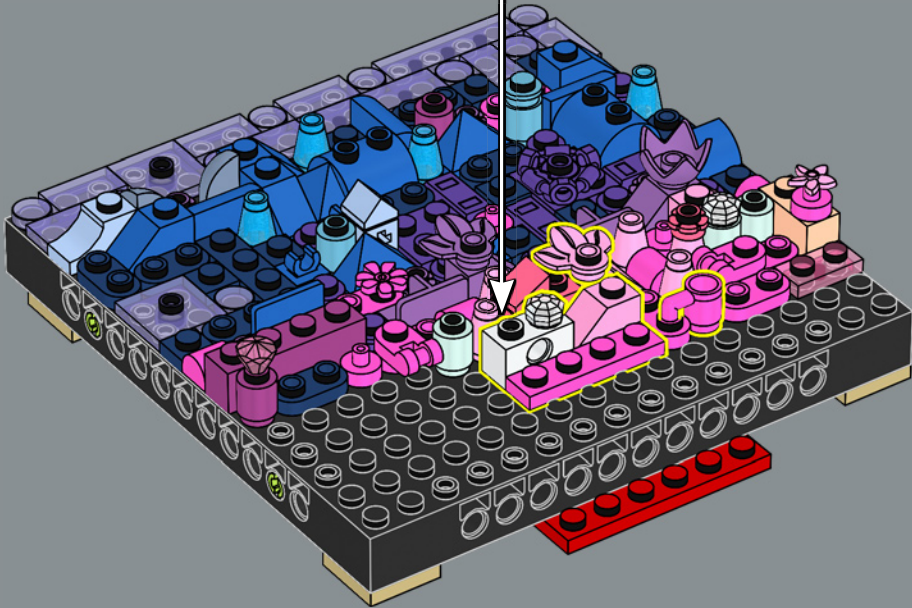
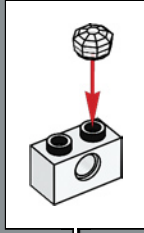

20

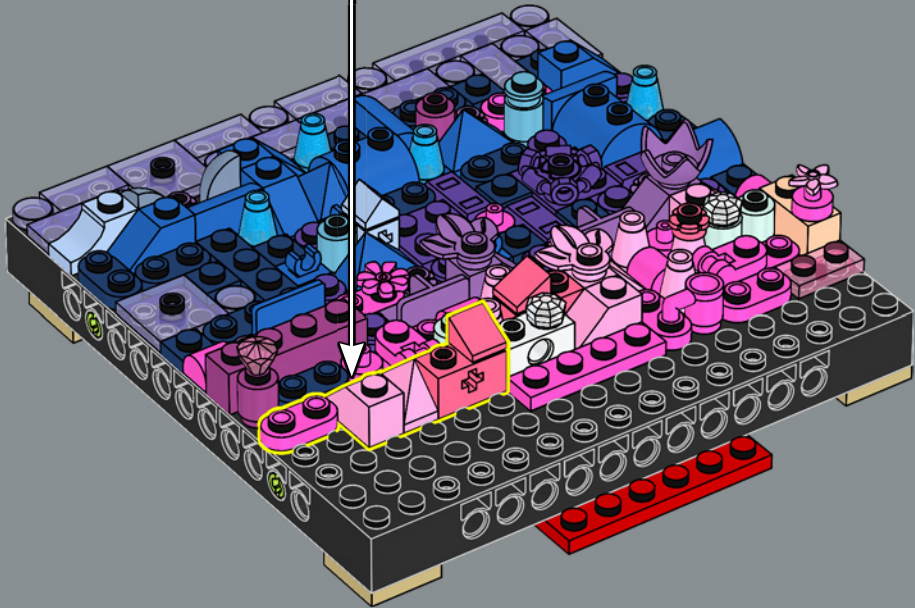
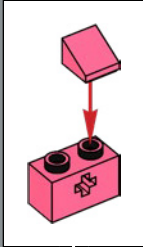



21

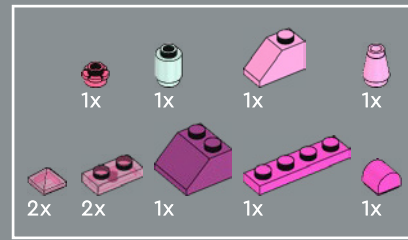
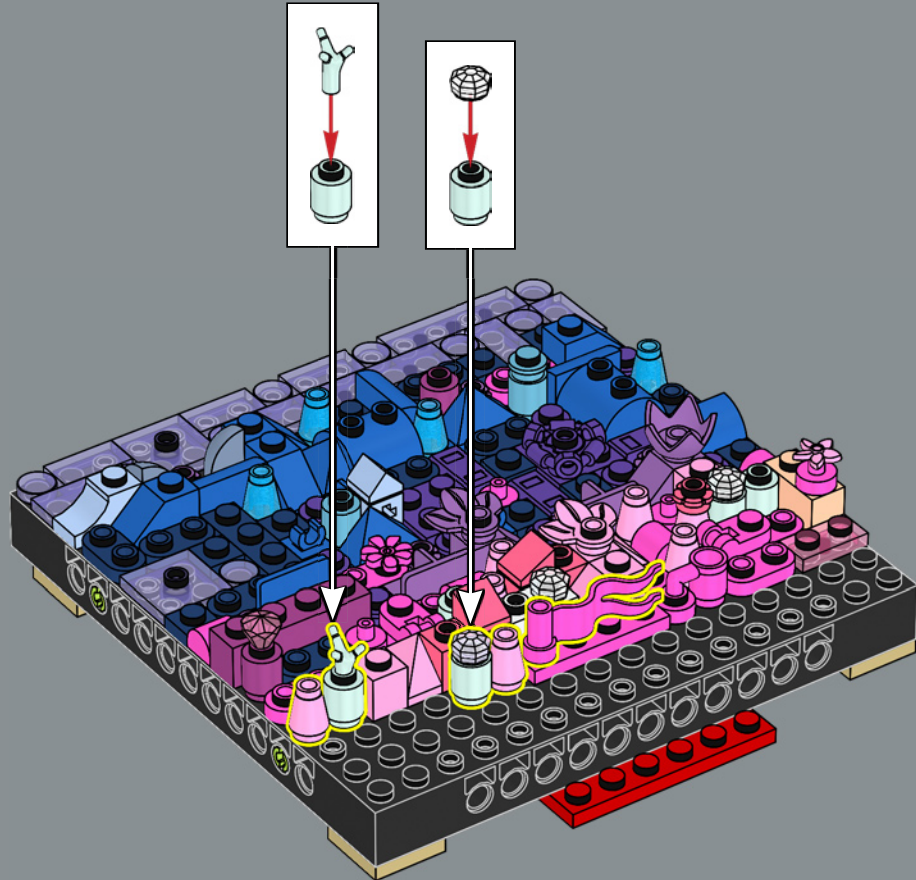

22

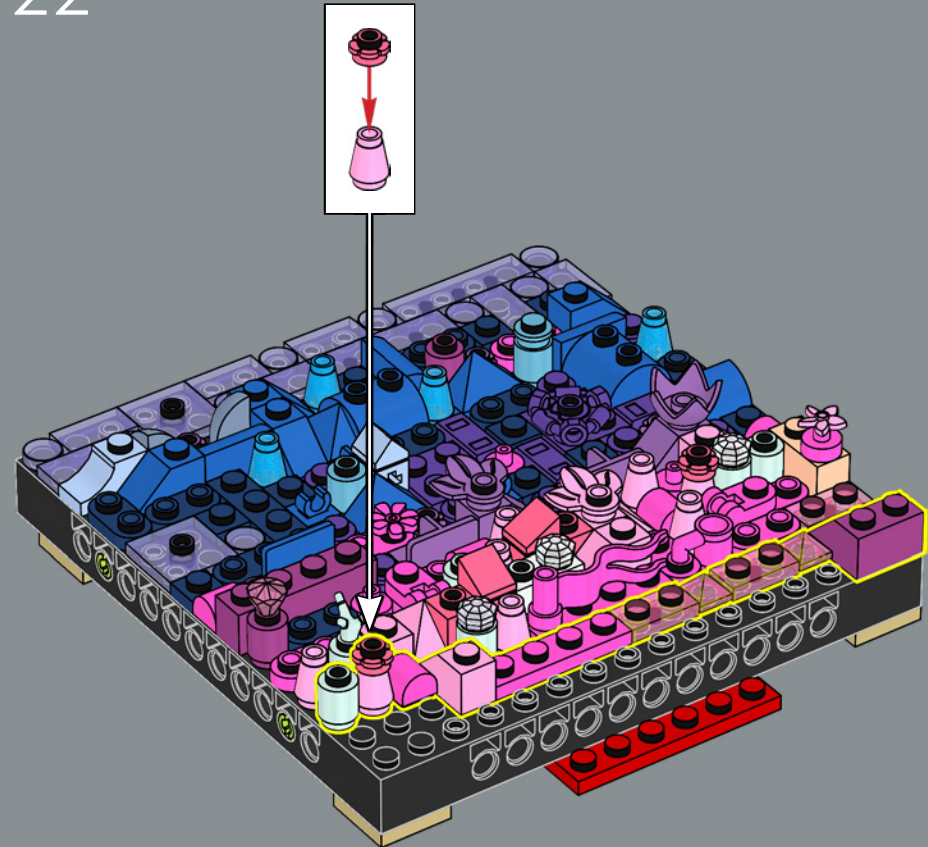

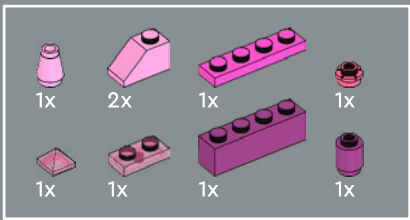

23

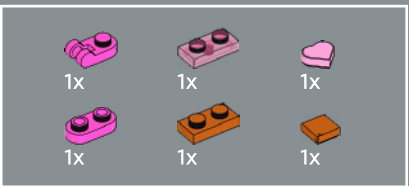
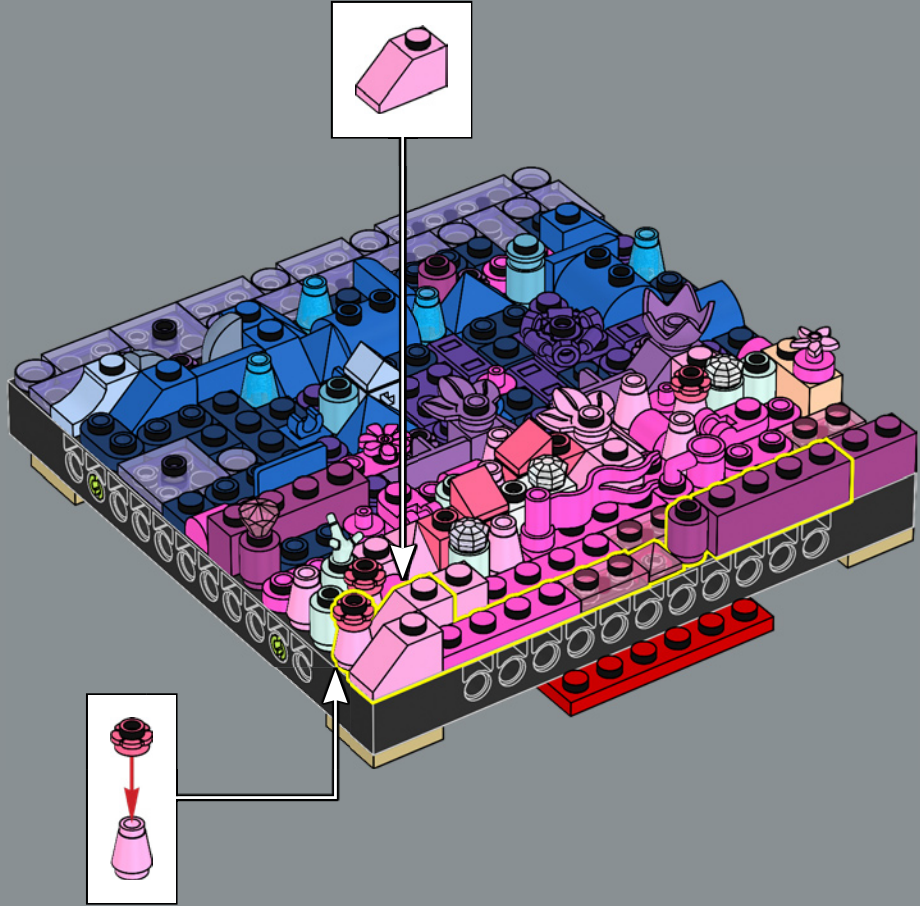

24

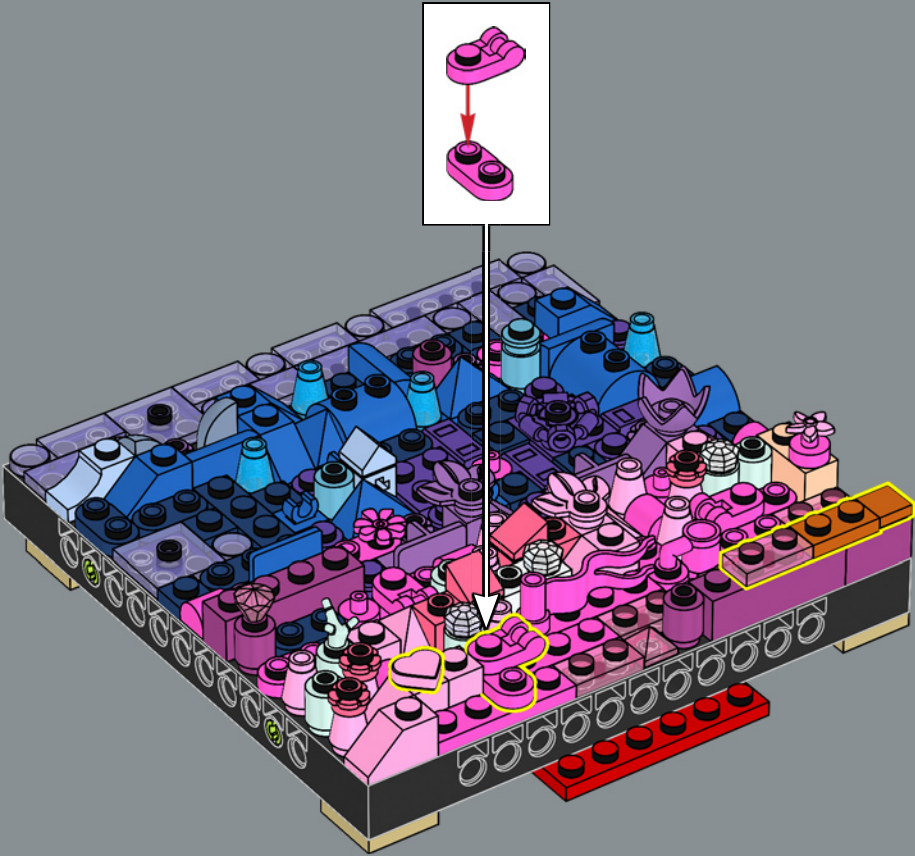

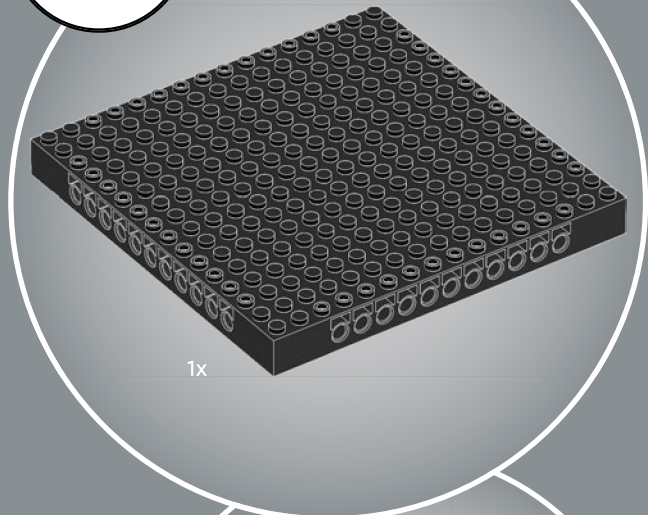
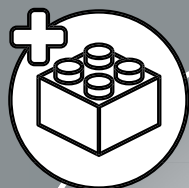

1x

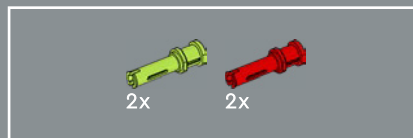
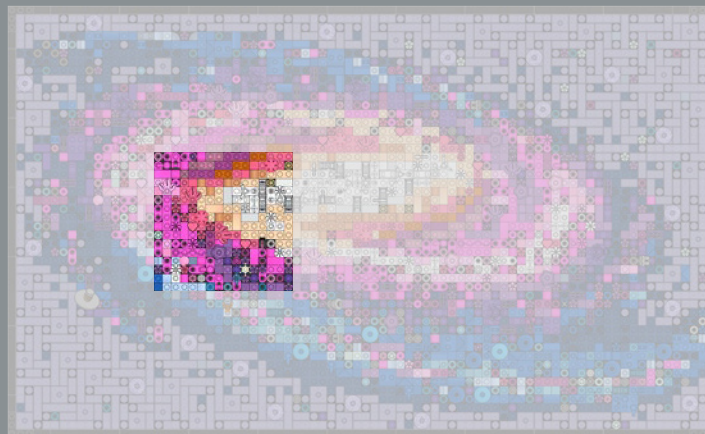

25

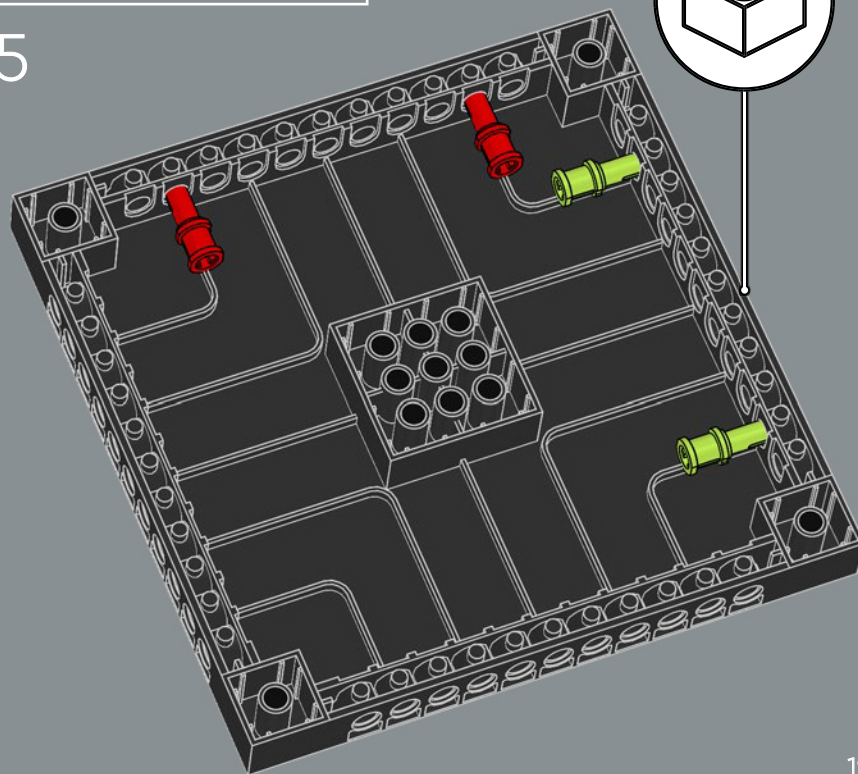
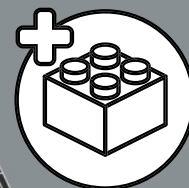

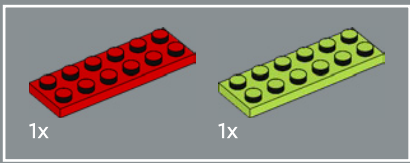

26

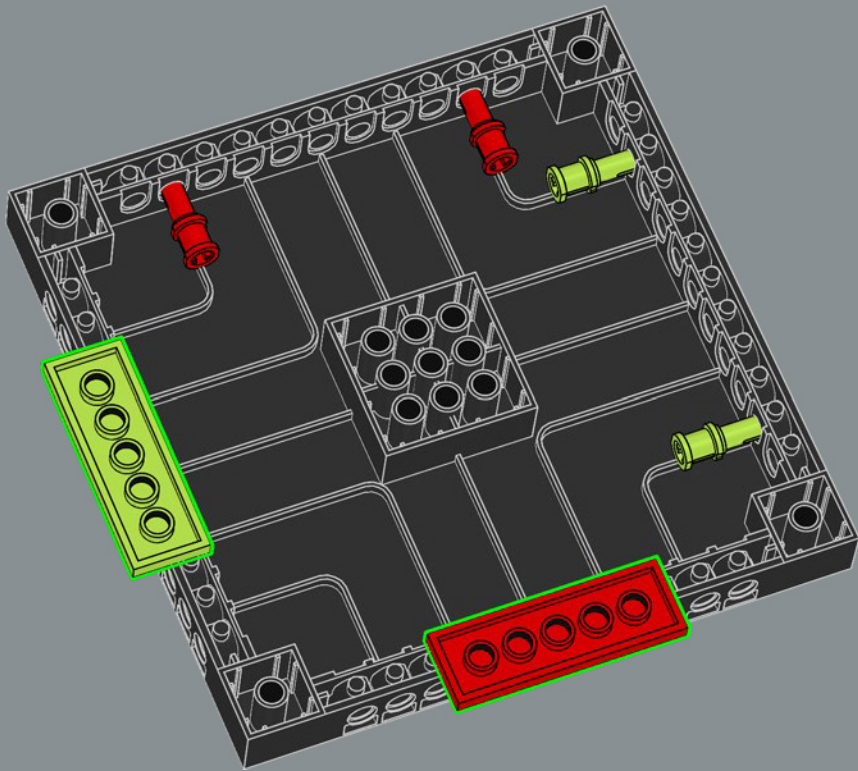

27

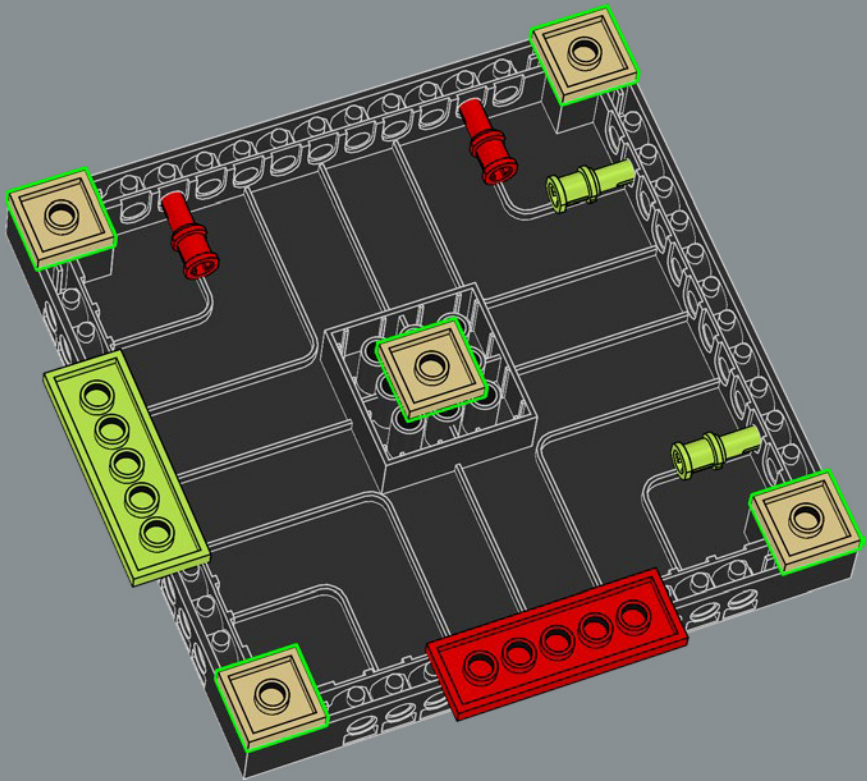

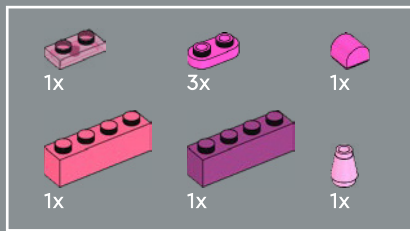

28

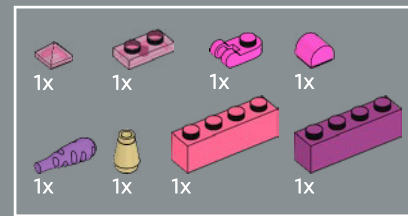
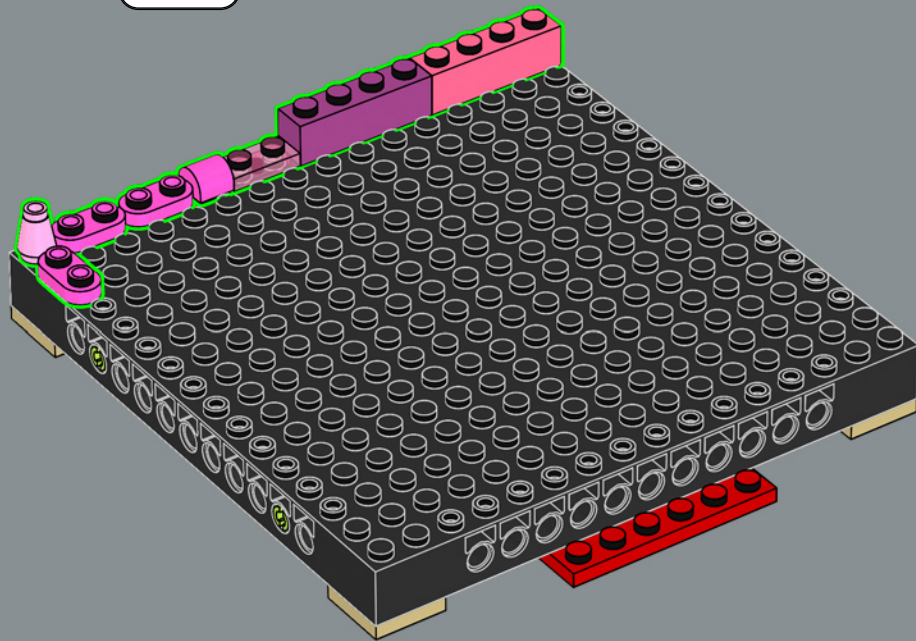

29

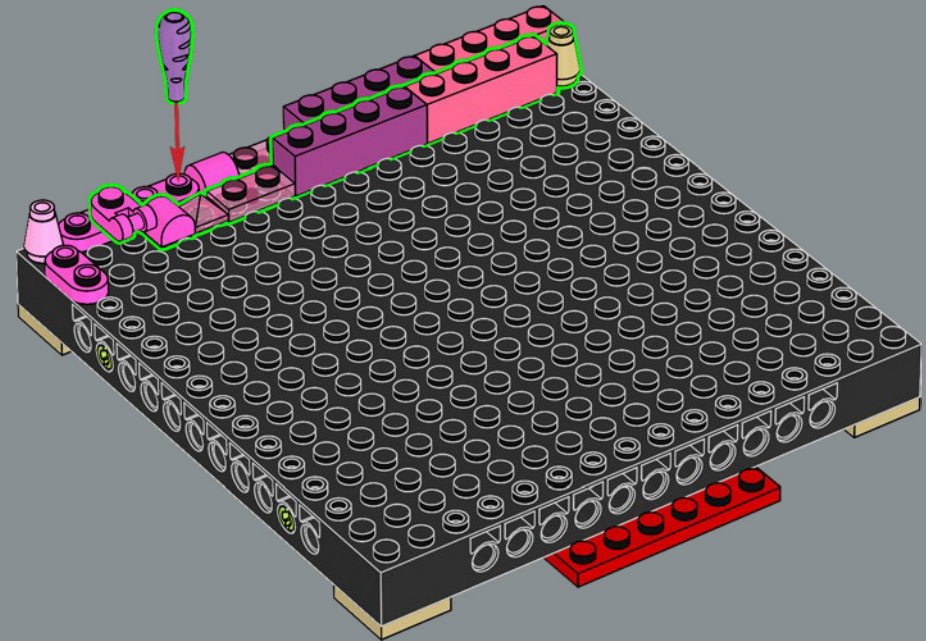

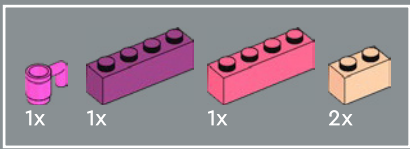

30

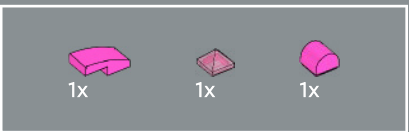
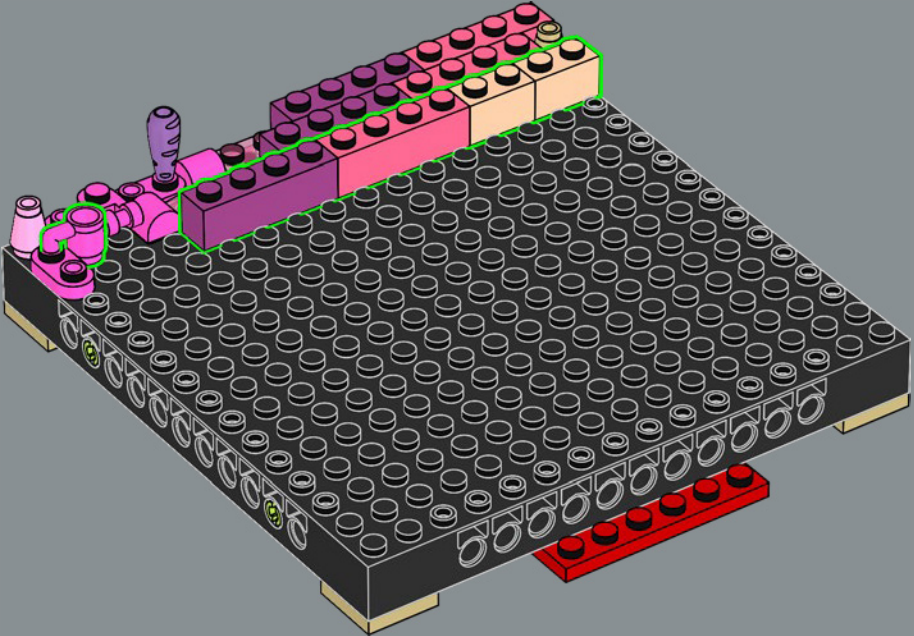

31

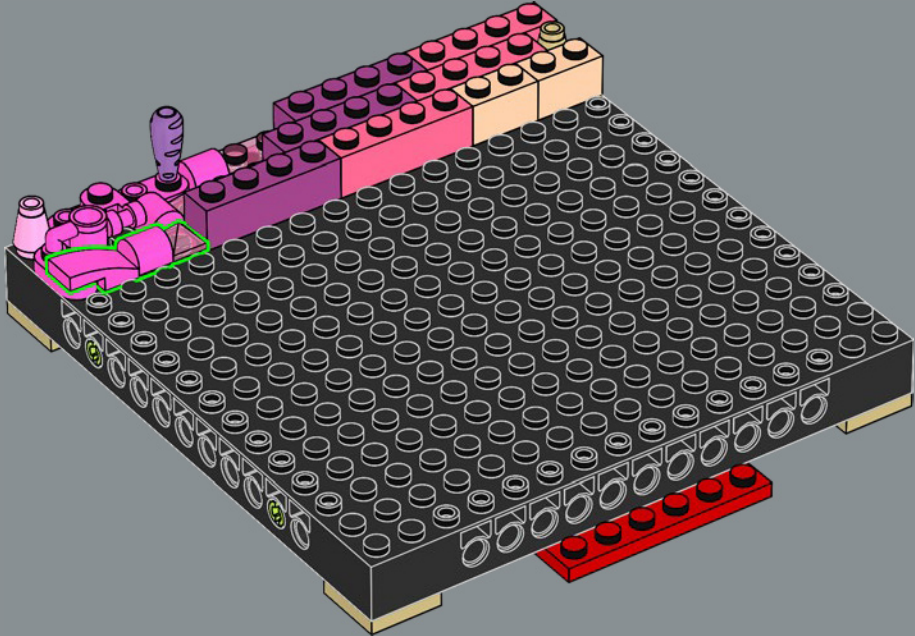

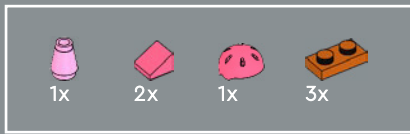

32

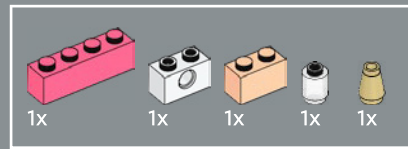
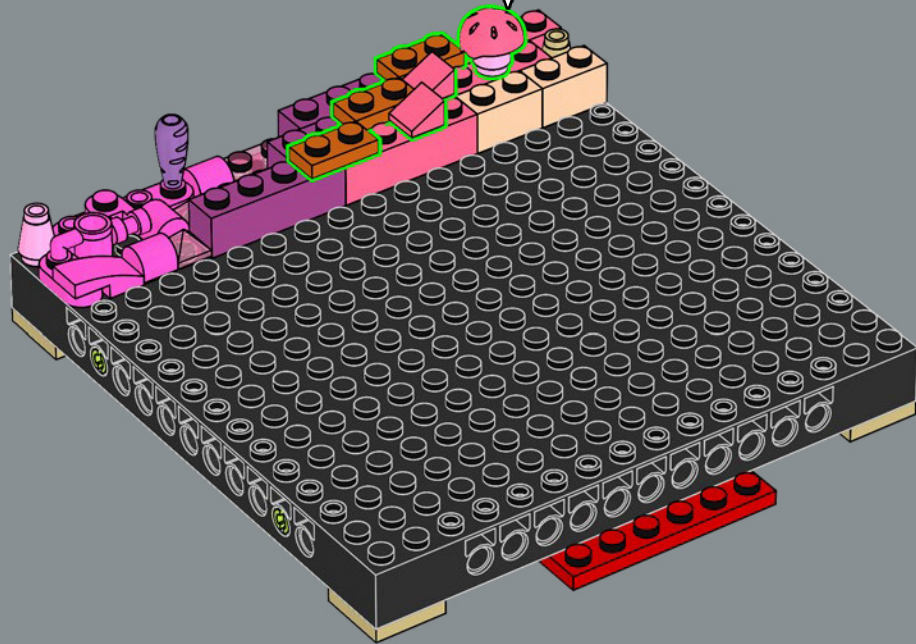
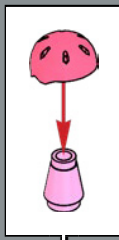

33

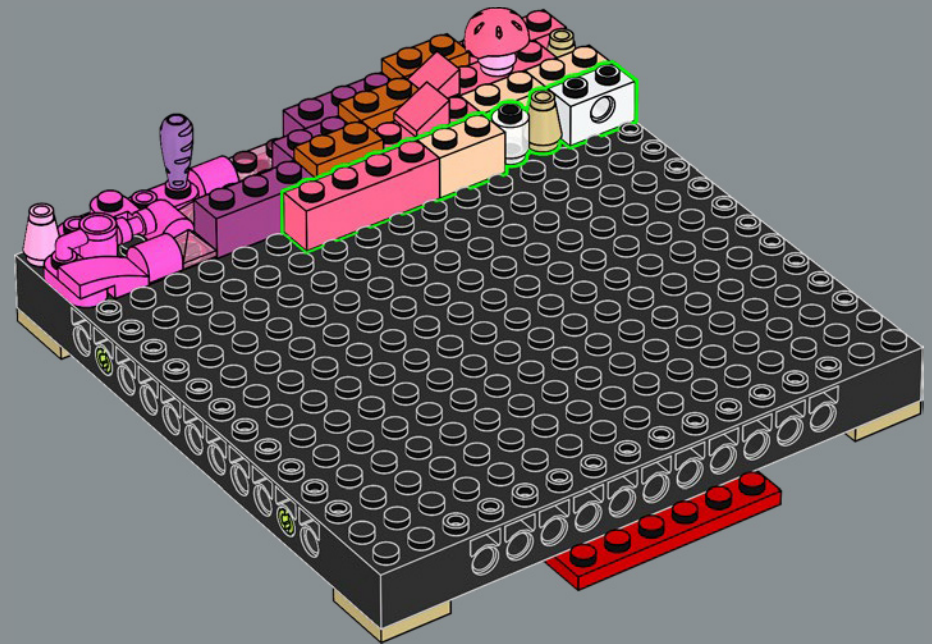



34

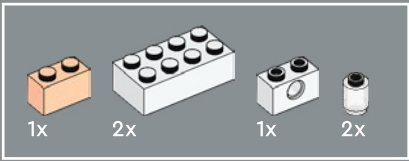
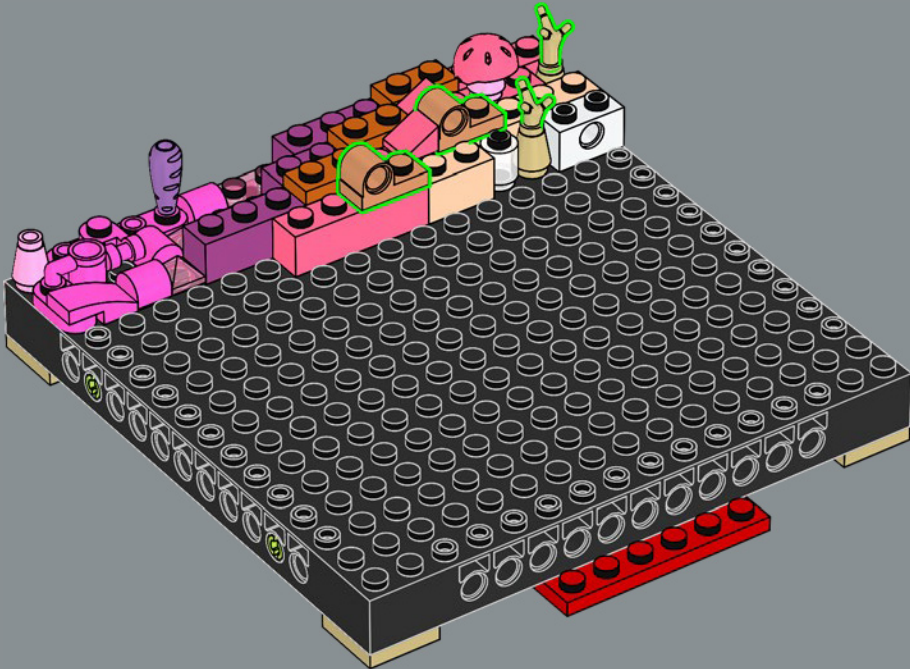

35

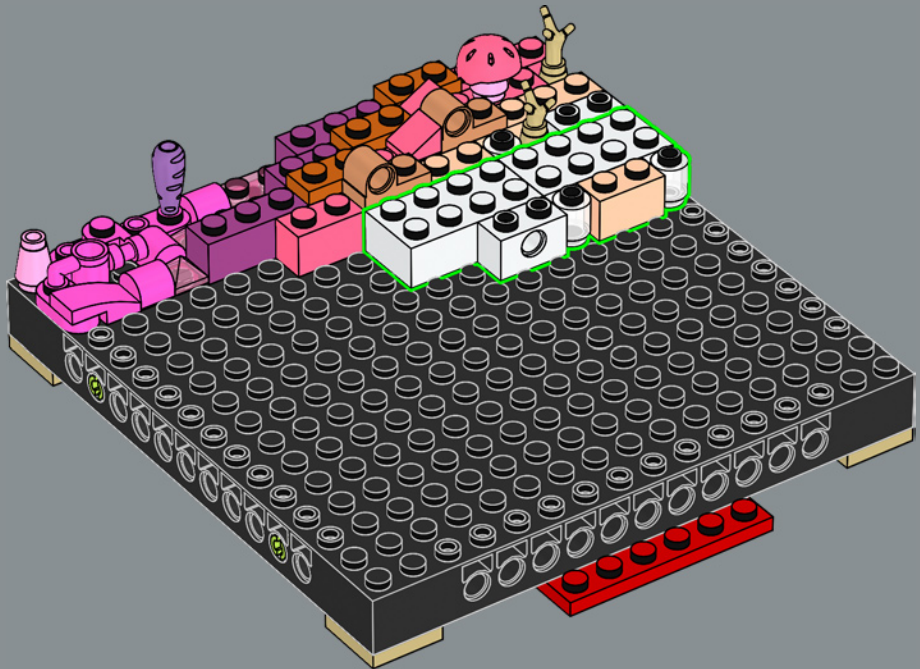

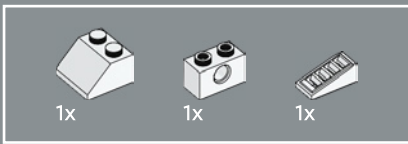

36

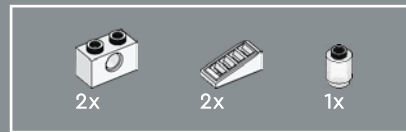
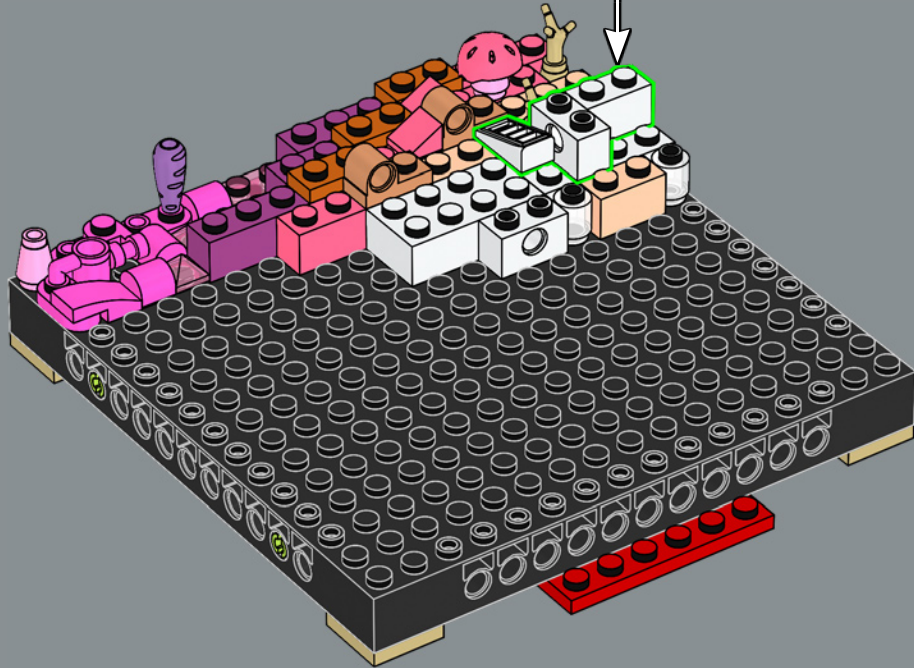
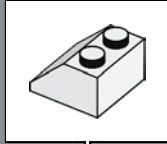

37

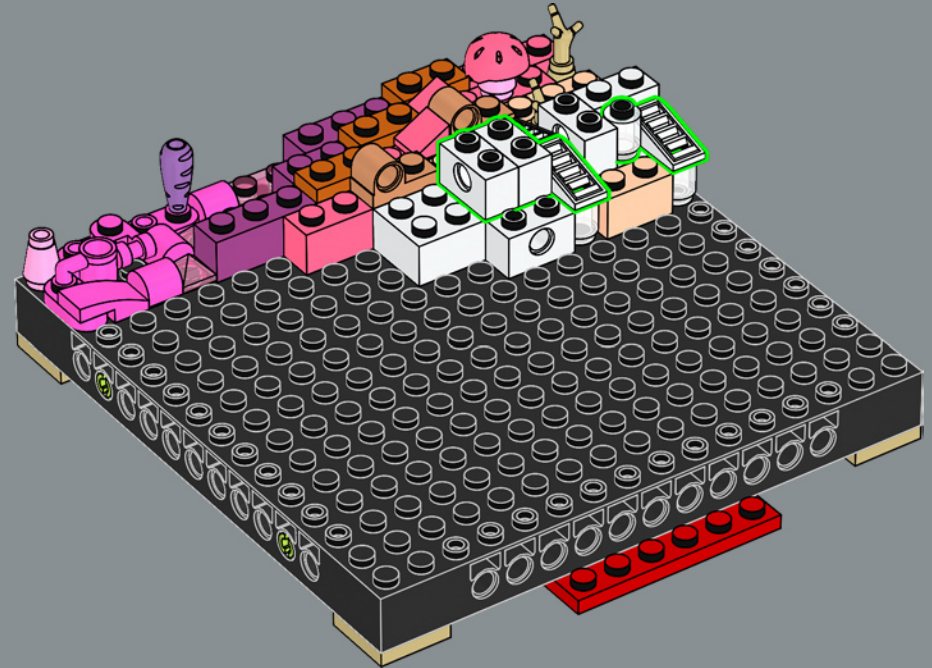

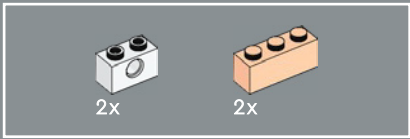

38

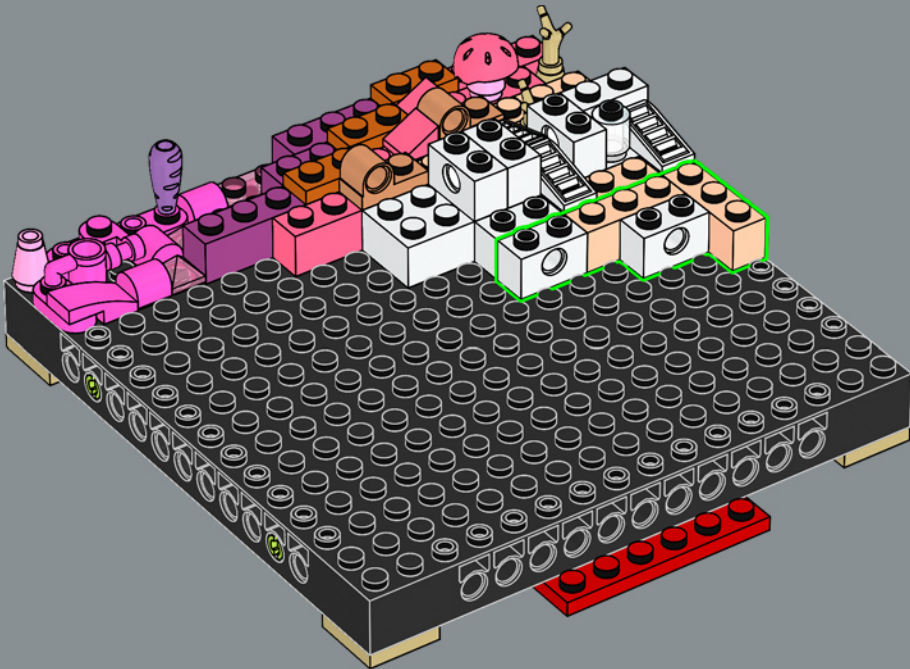

39

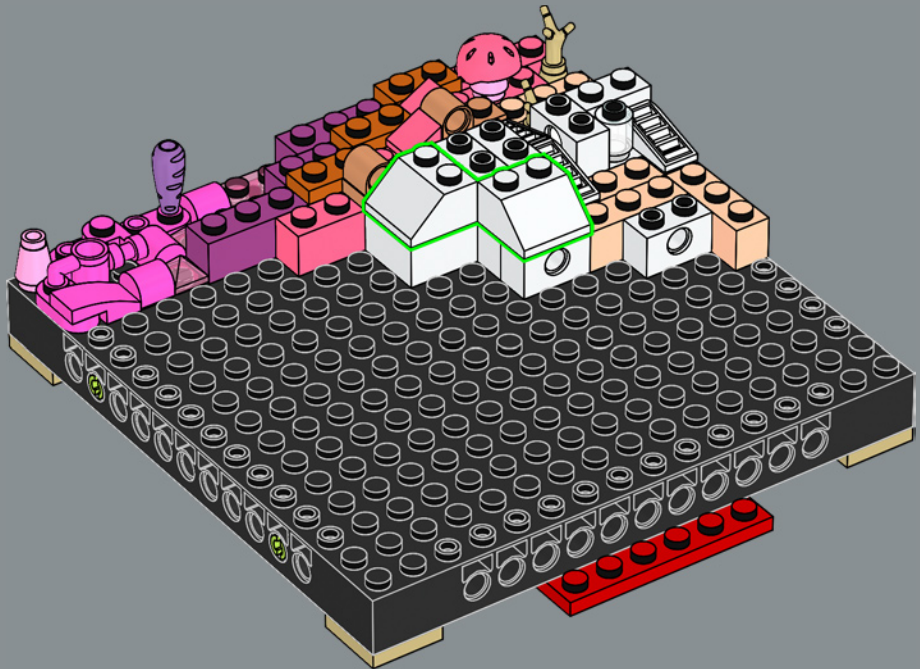

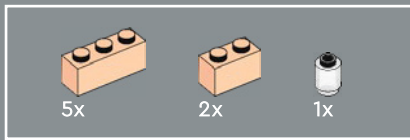

40

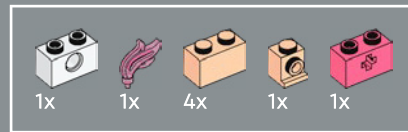
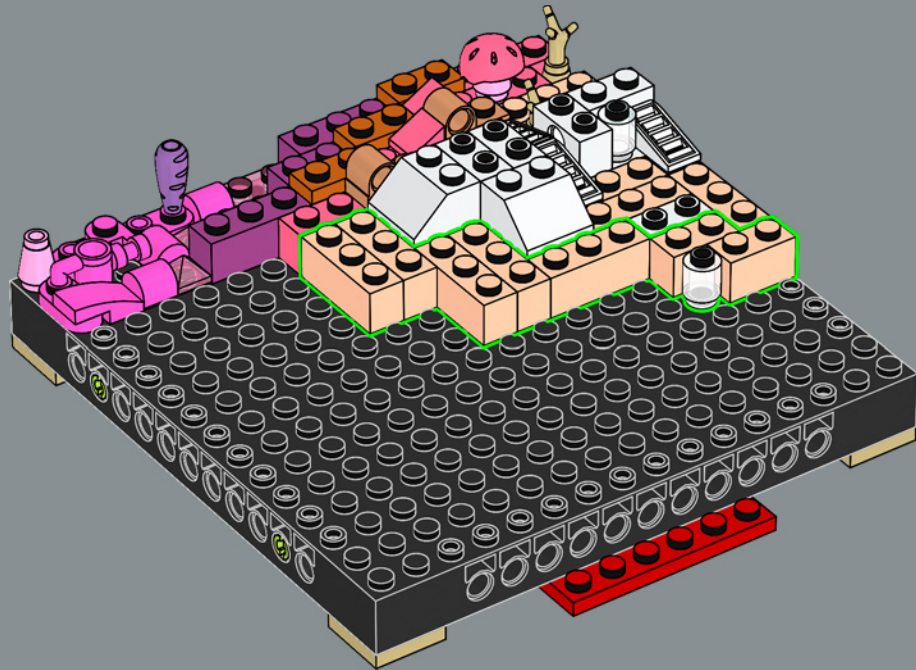

41

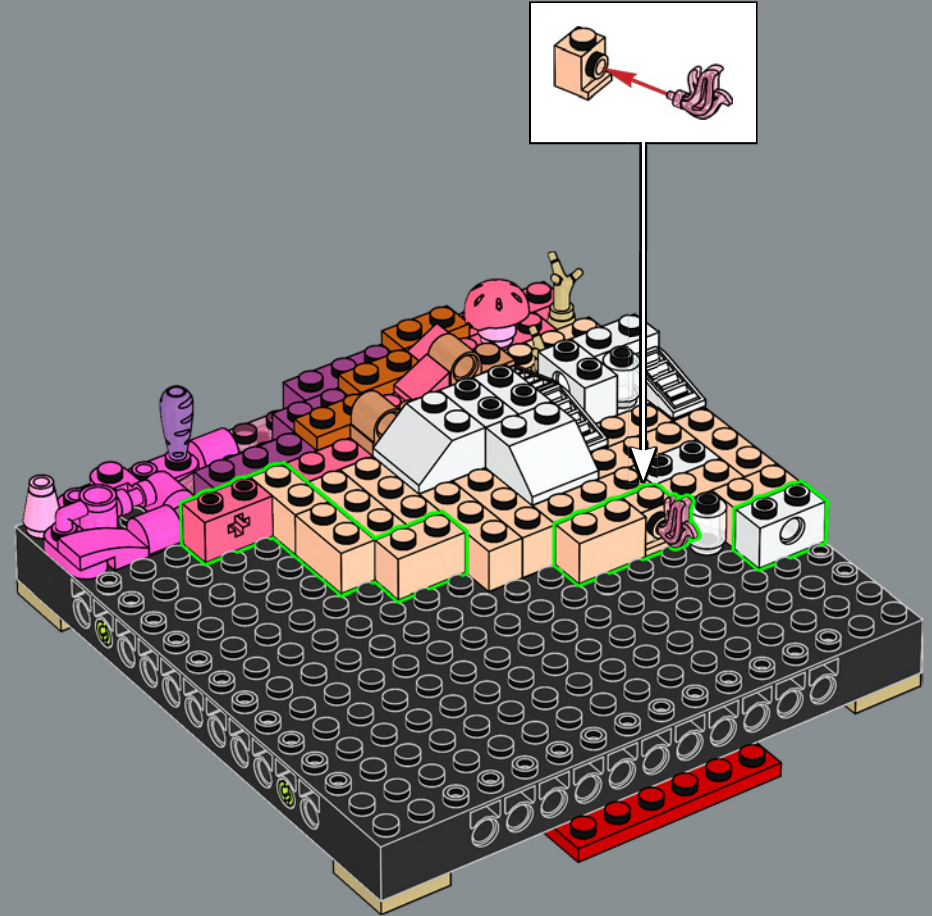

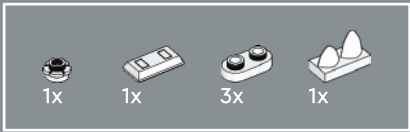

42

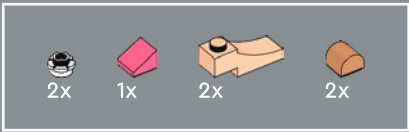
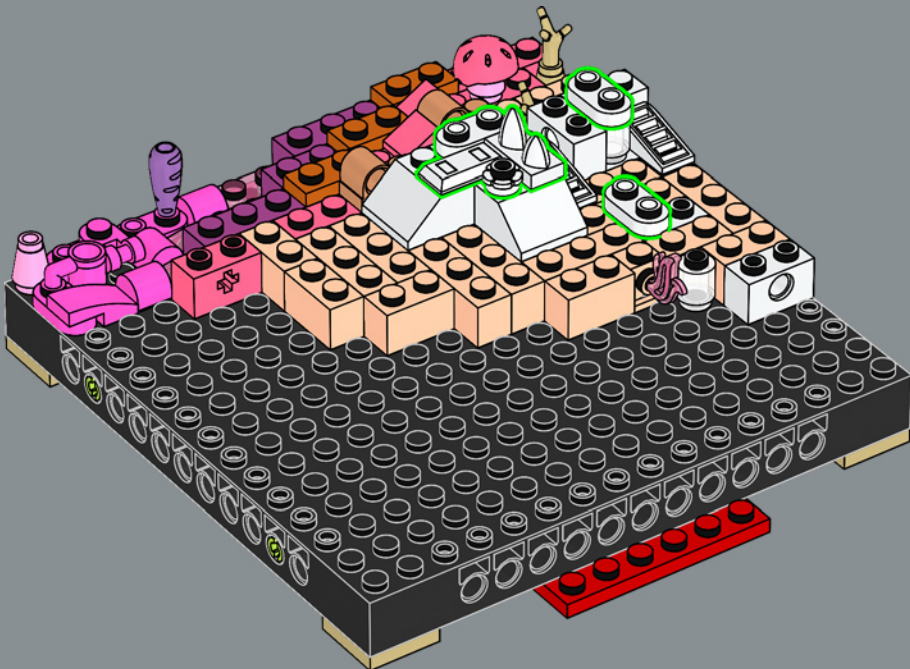

43

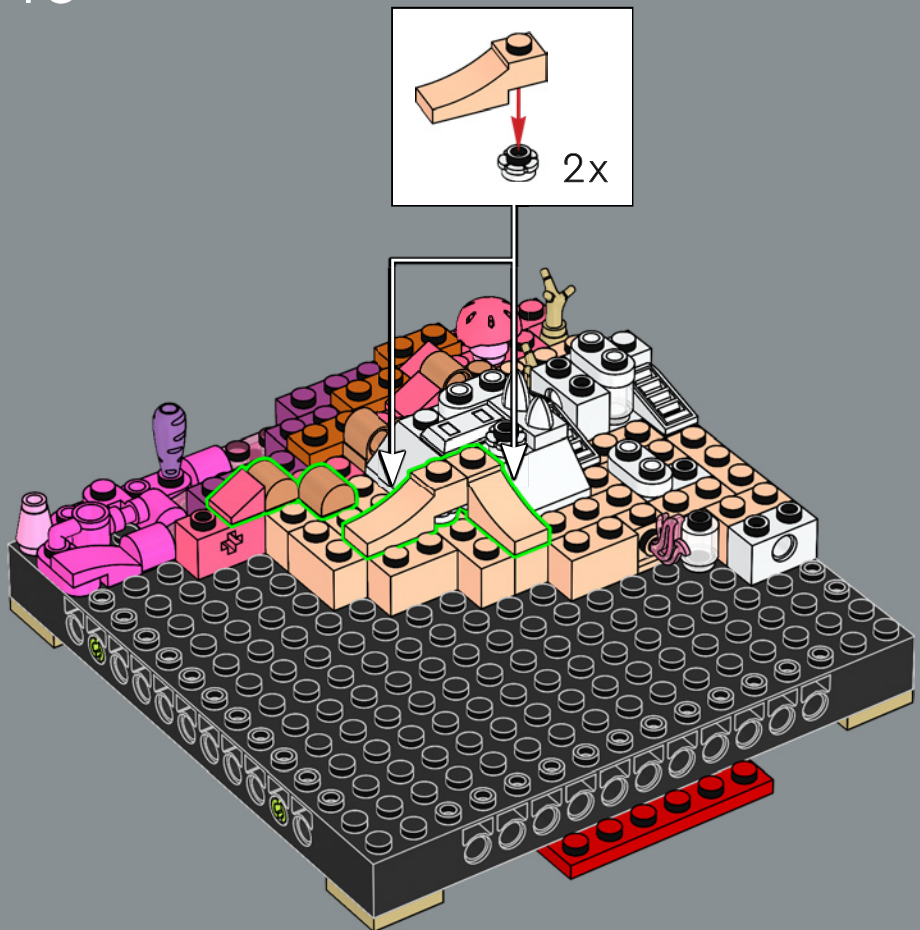

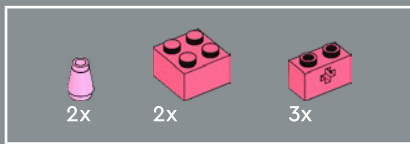

44

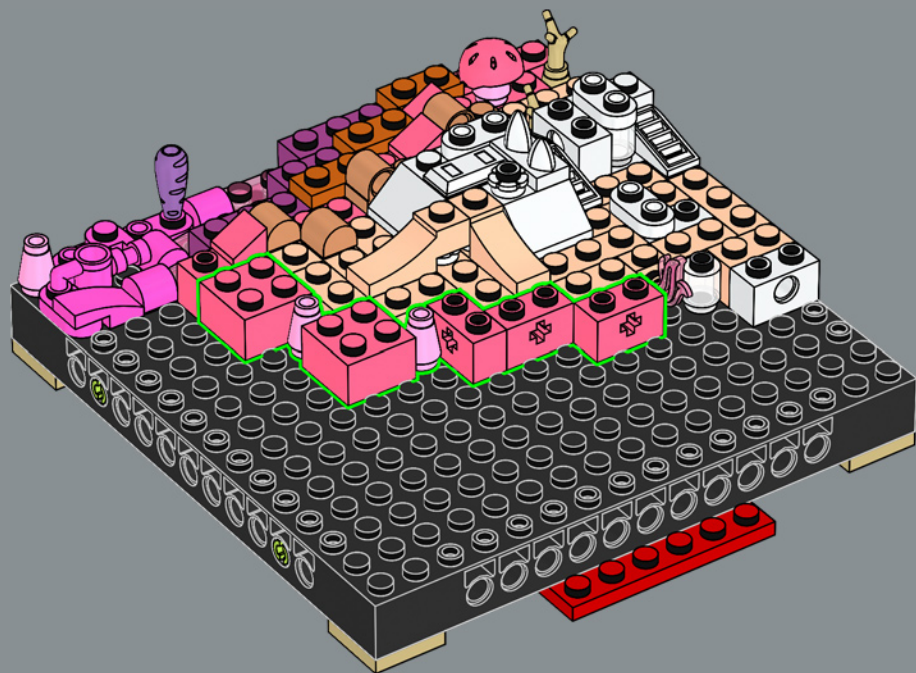

45

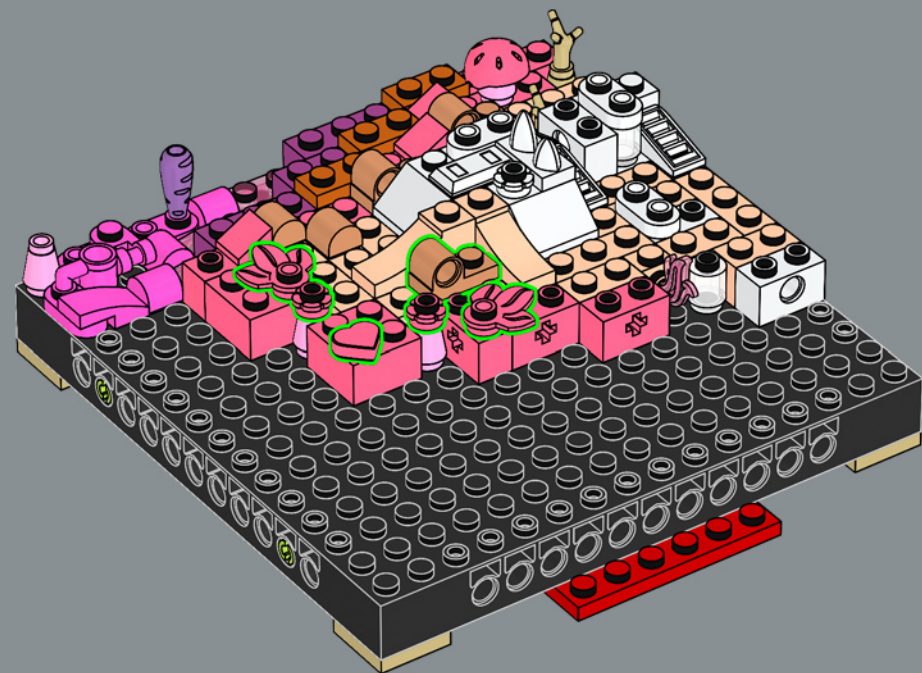

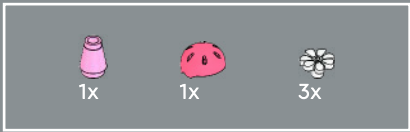

46

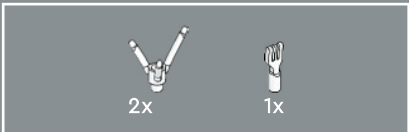

47

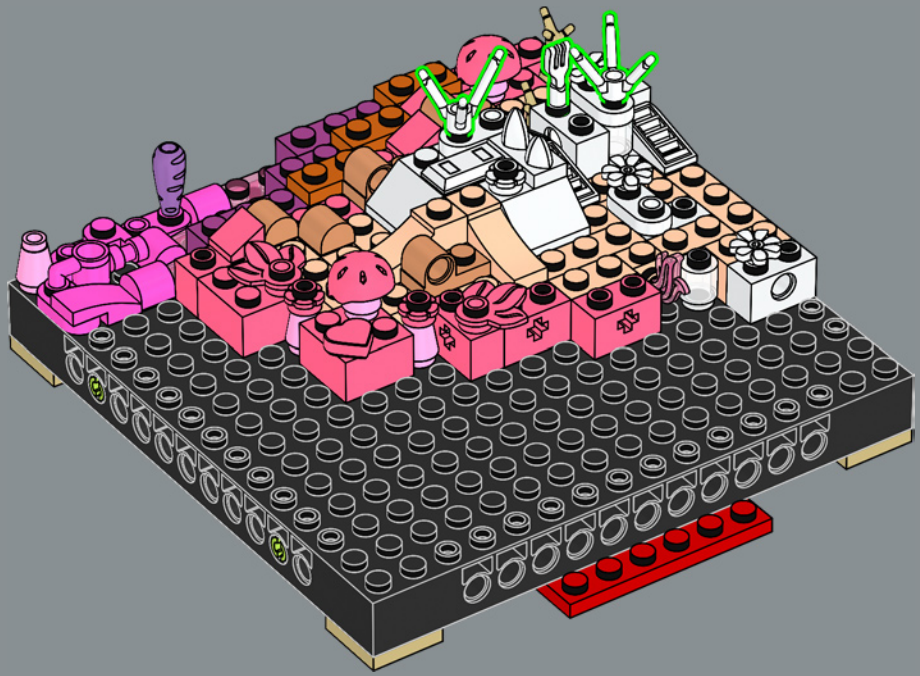

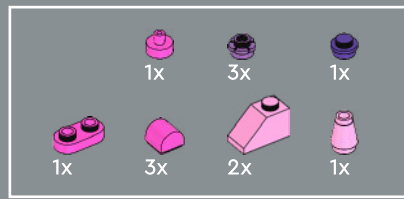

48

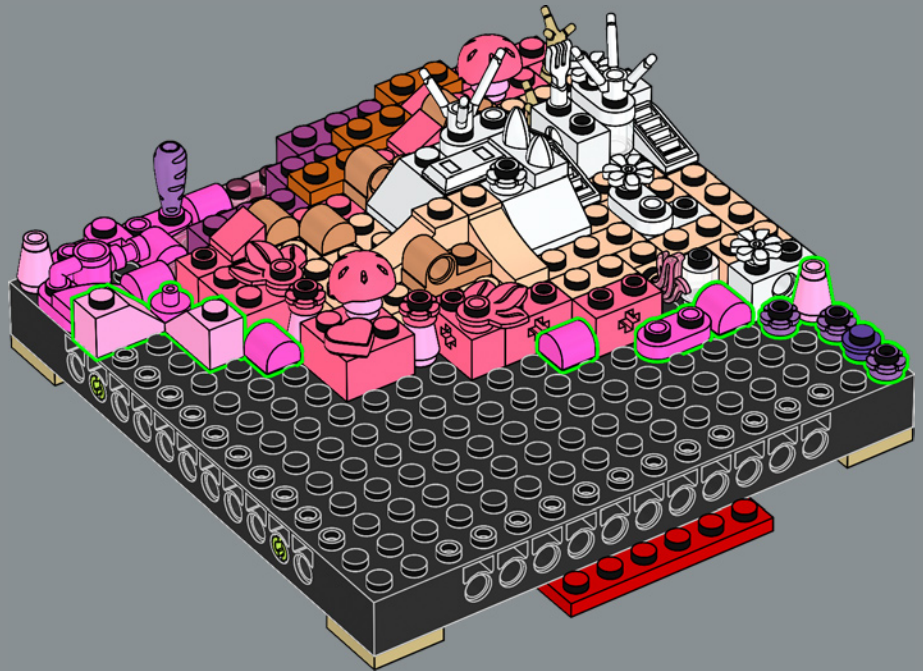

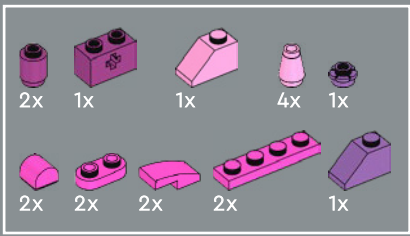

49

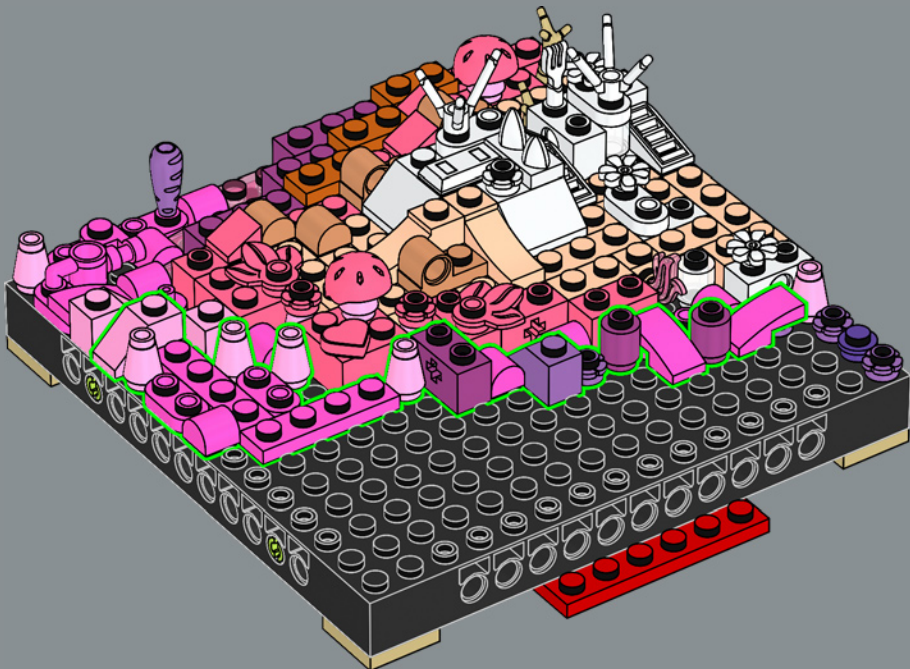

50

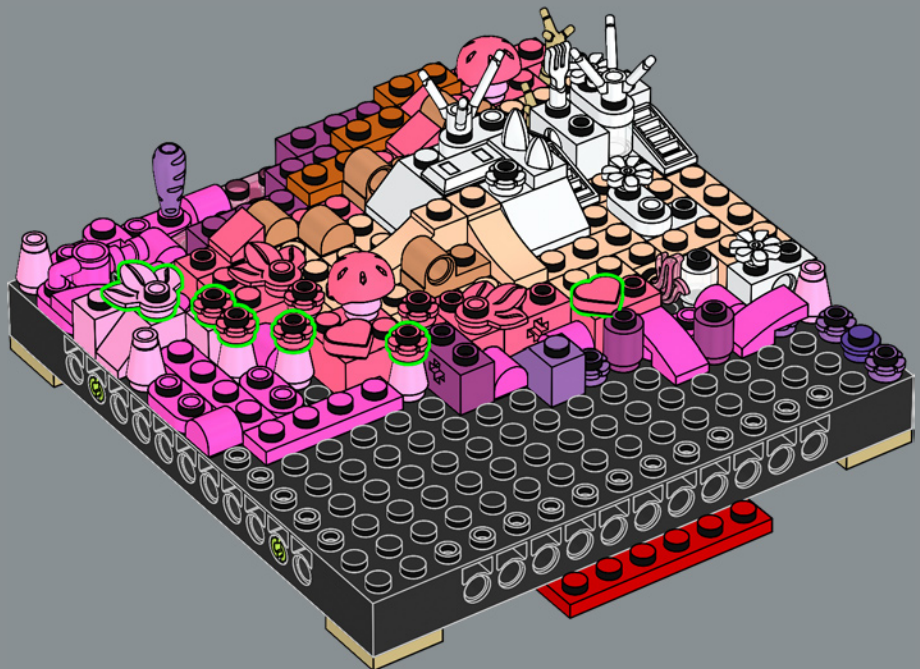

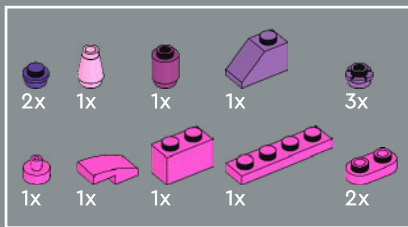

51

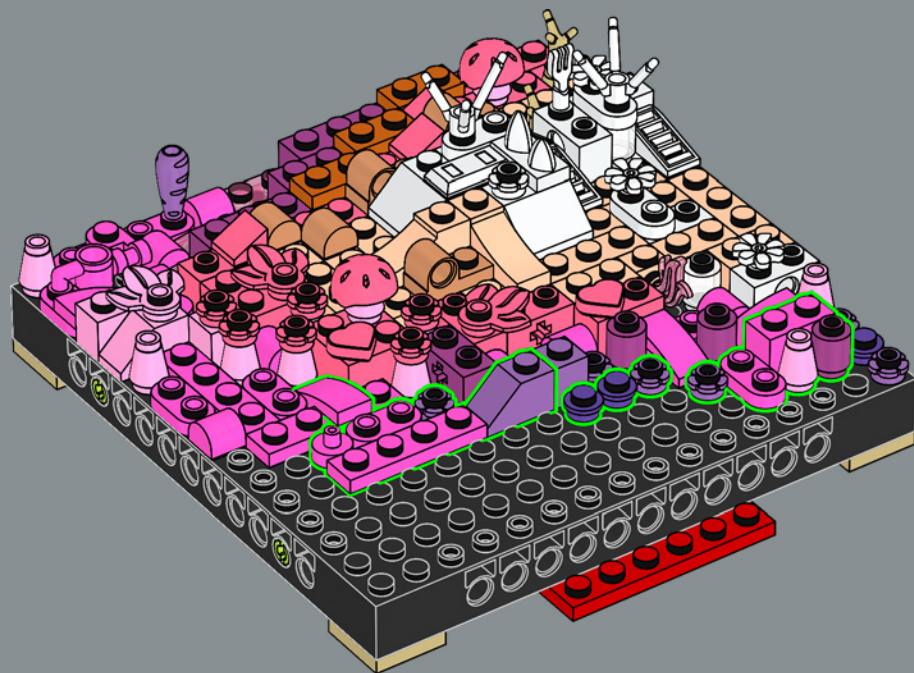

52

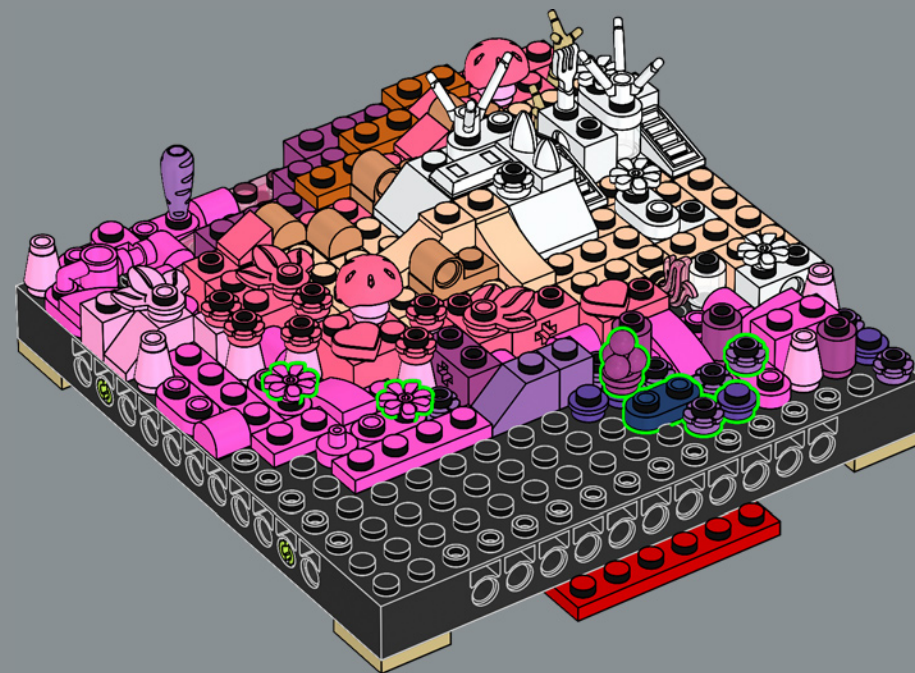

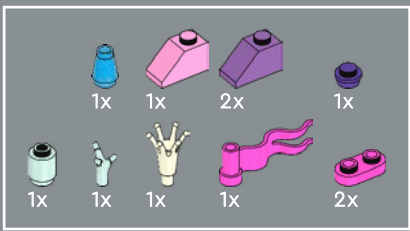

53

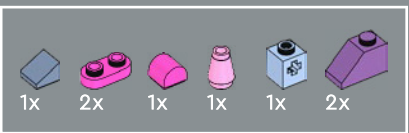
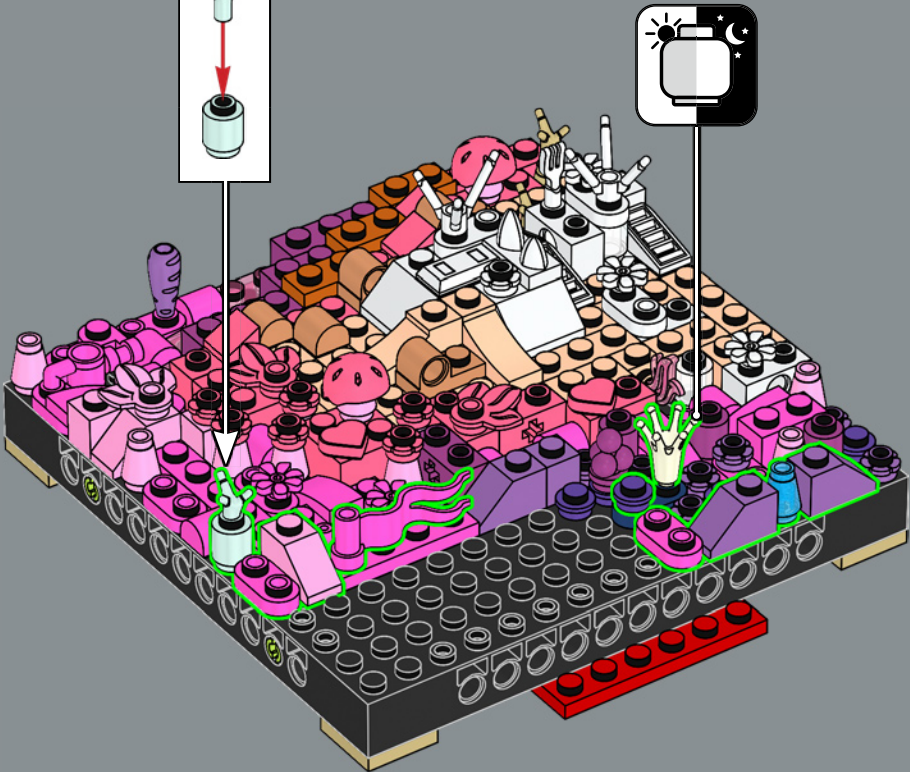
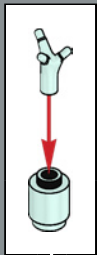

54

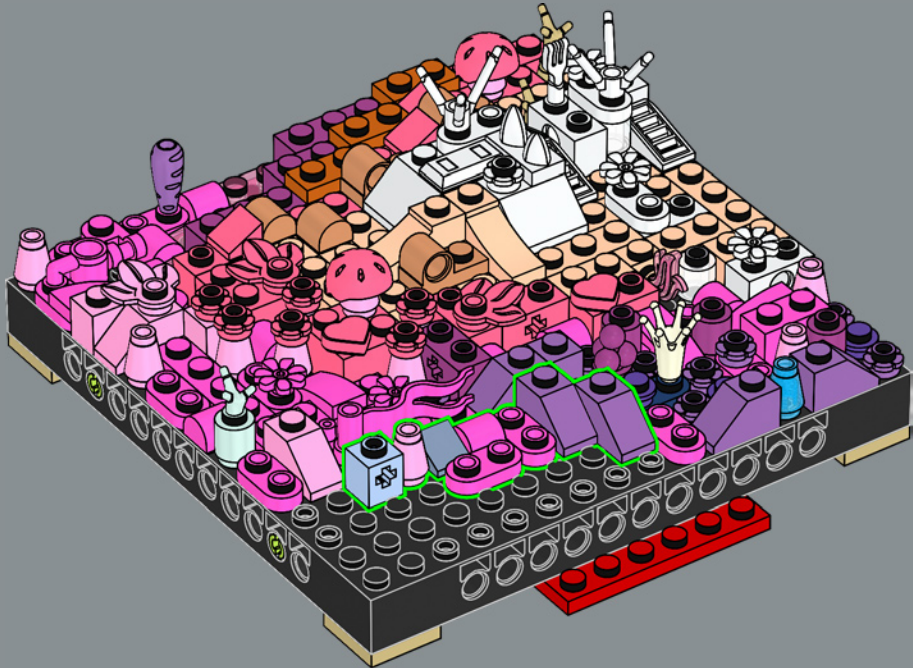



55

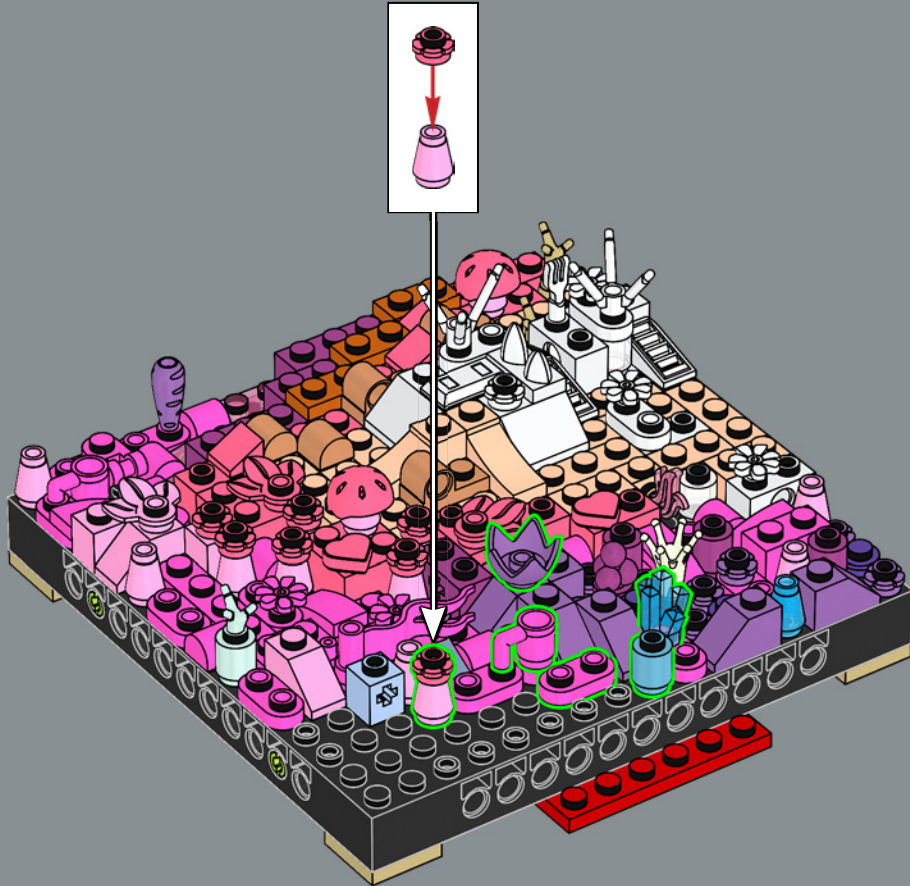

56

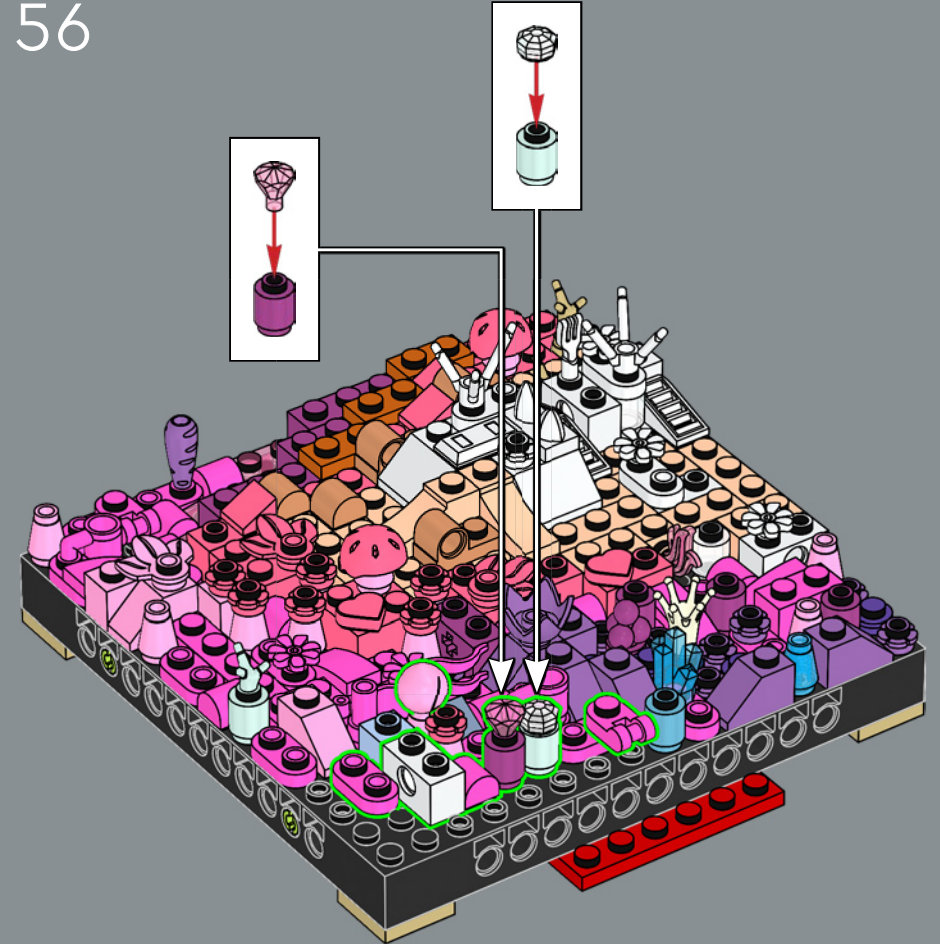

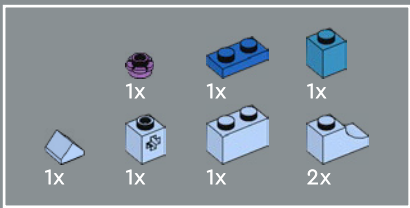

57

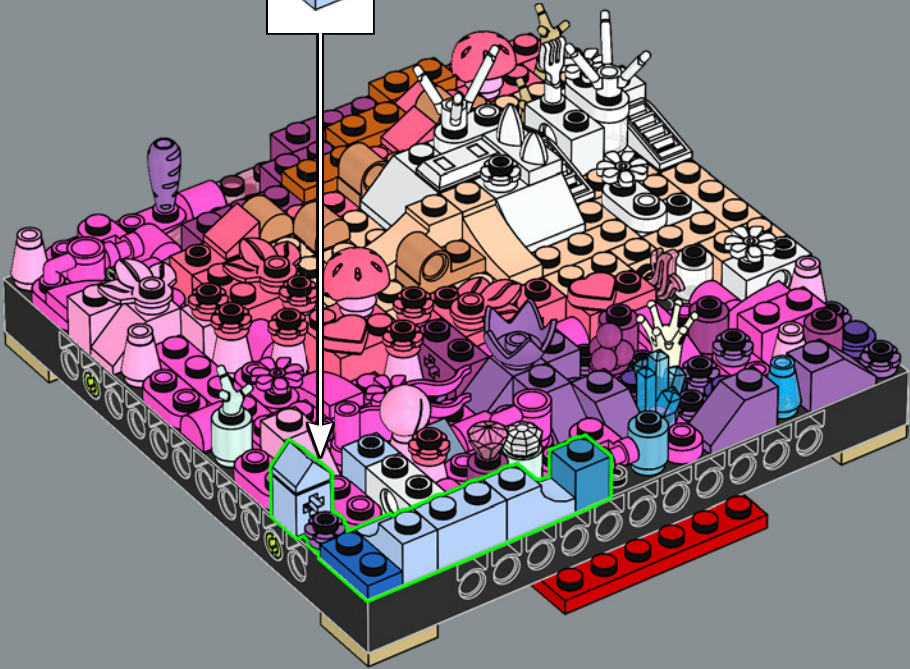
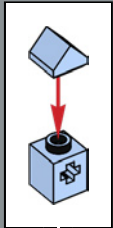

58

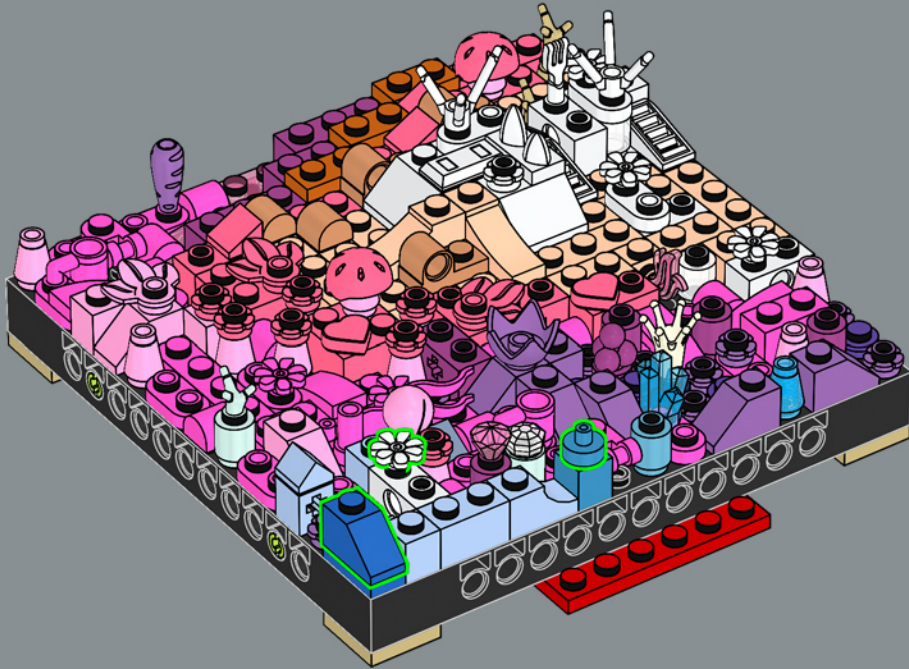

59

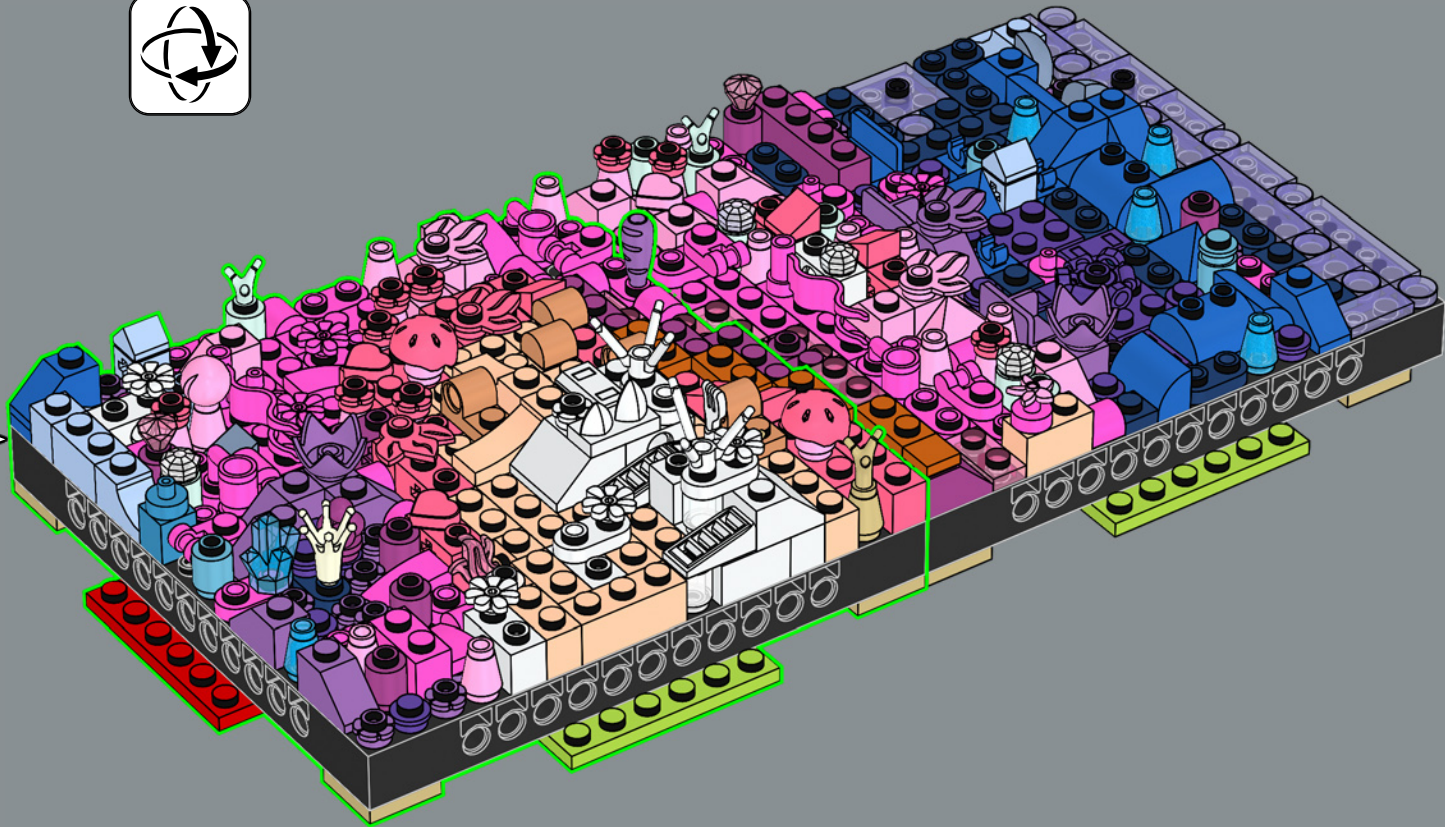

60

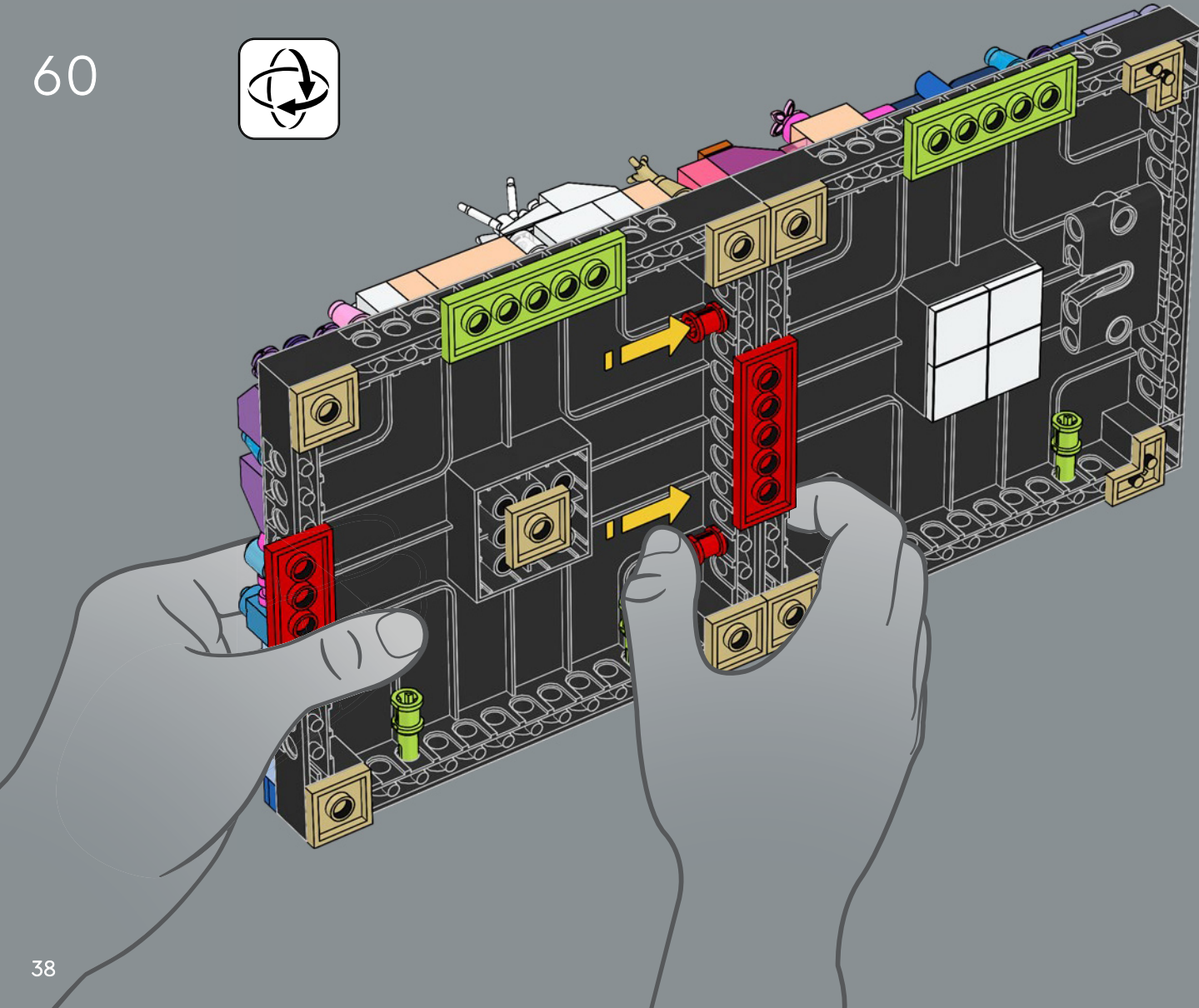

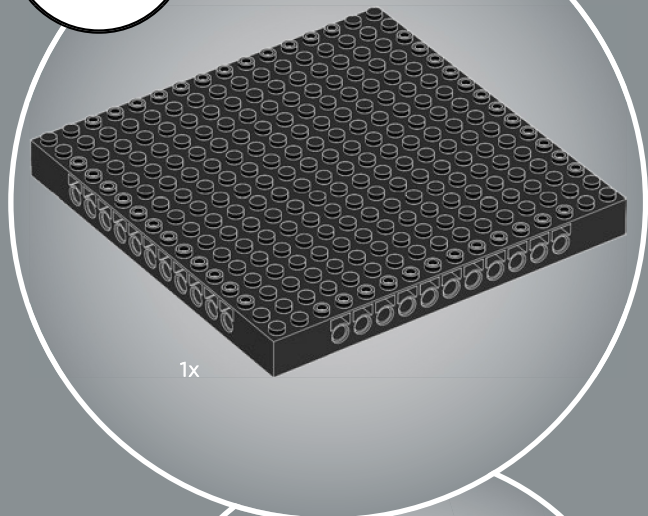
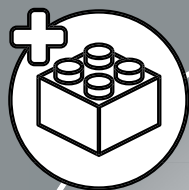

1x



13

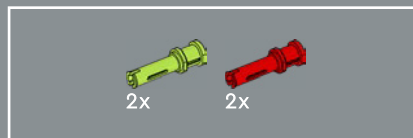
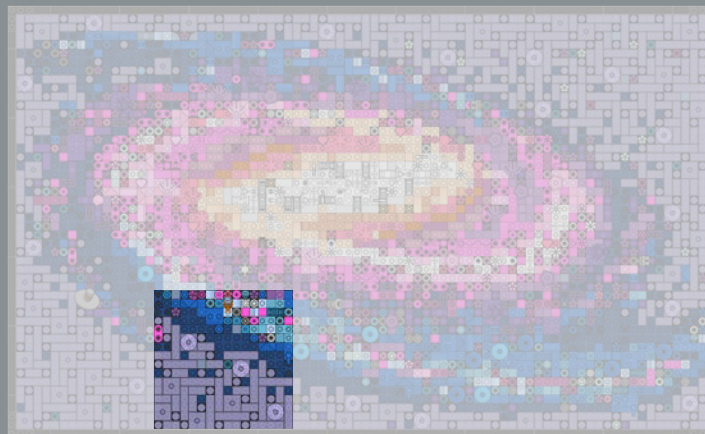

2x

2x

61

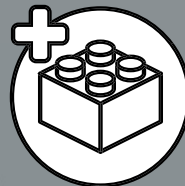
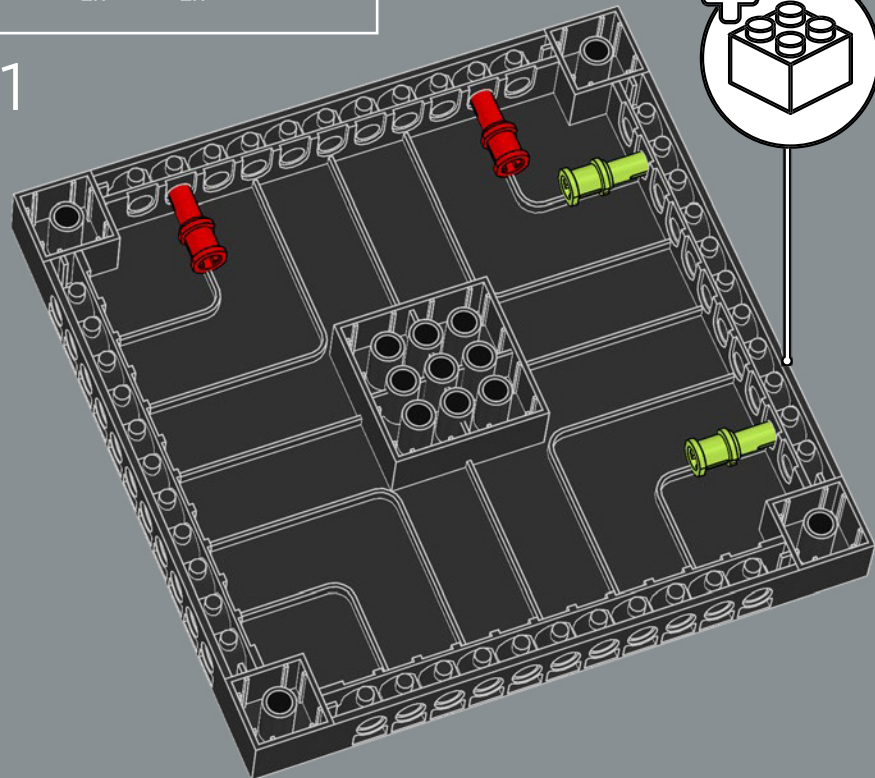

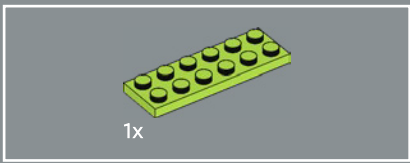

62

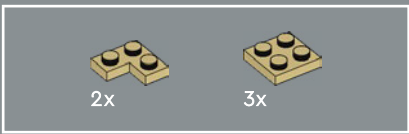
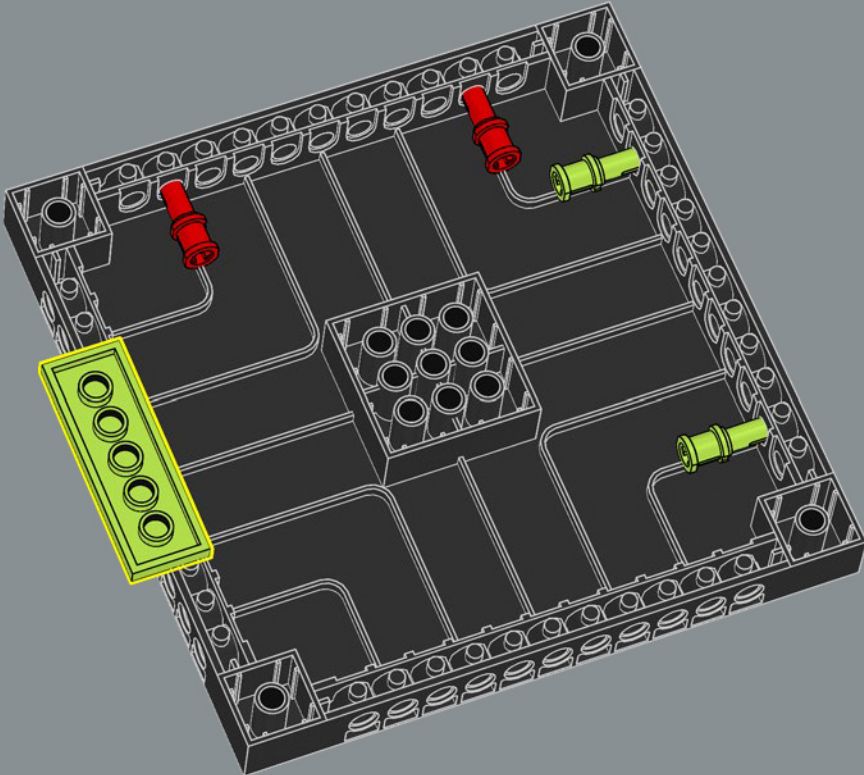

63

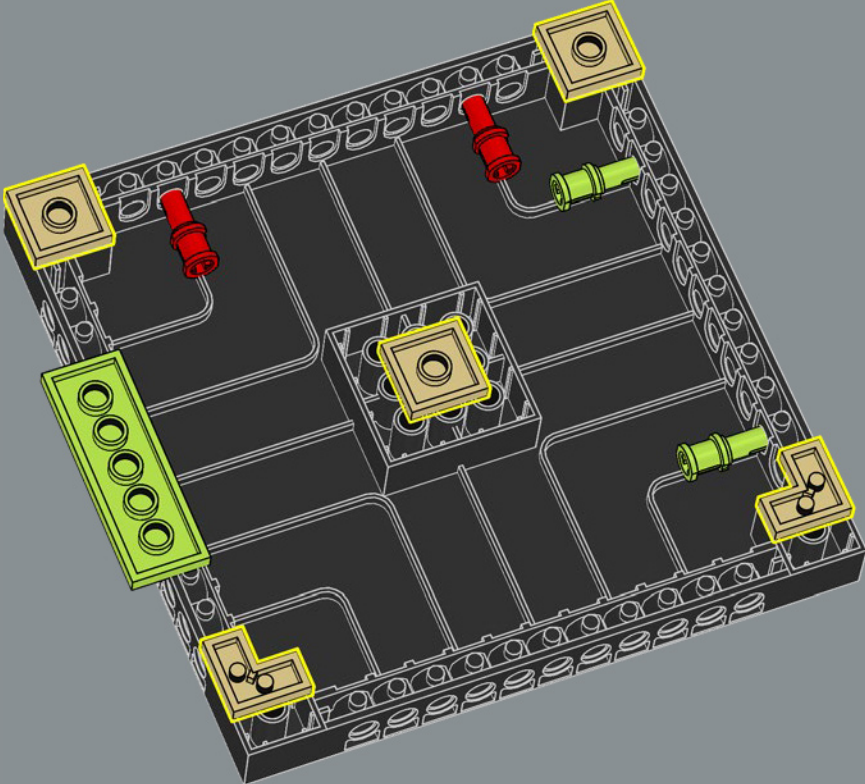

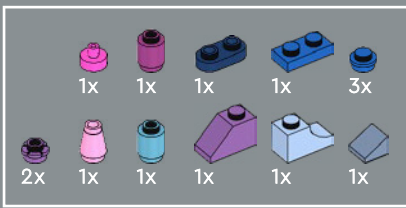

64

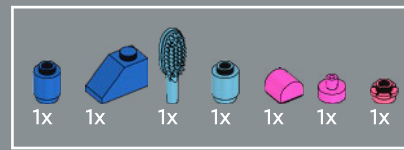
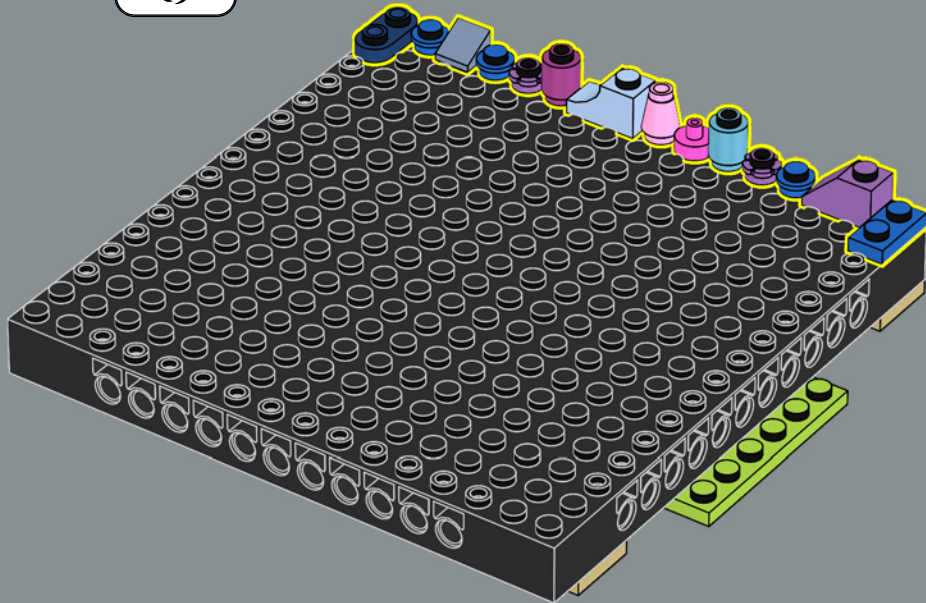

65

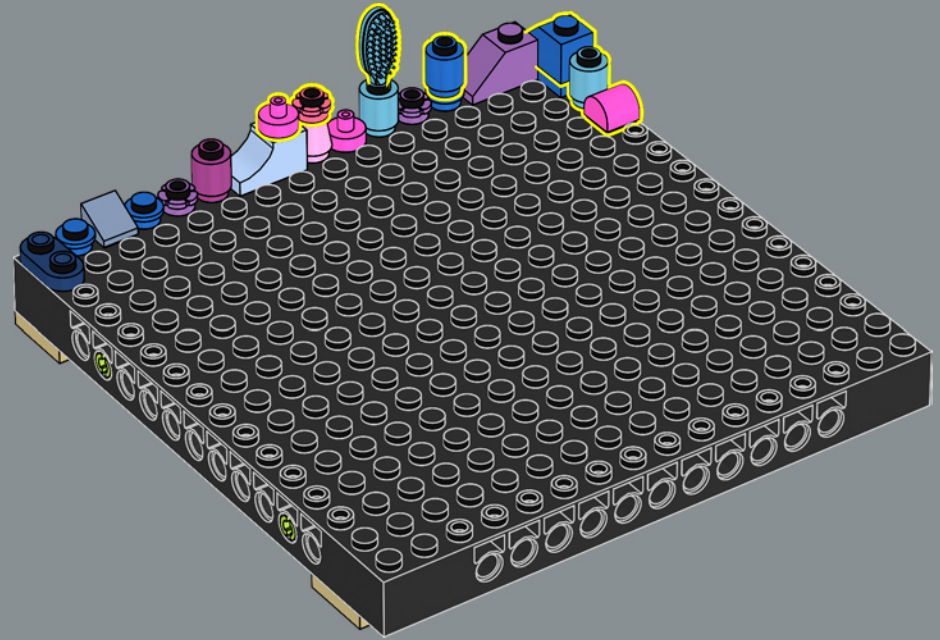

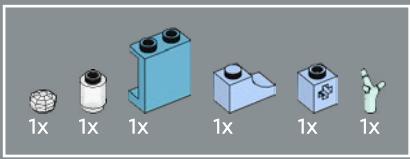

66

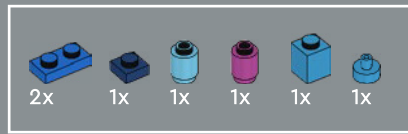
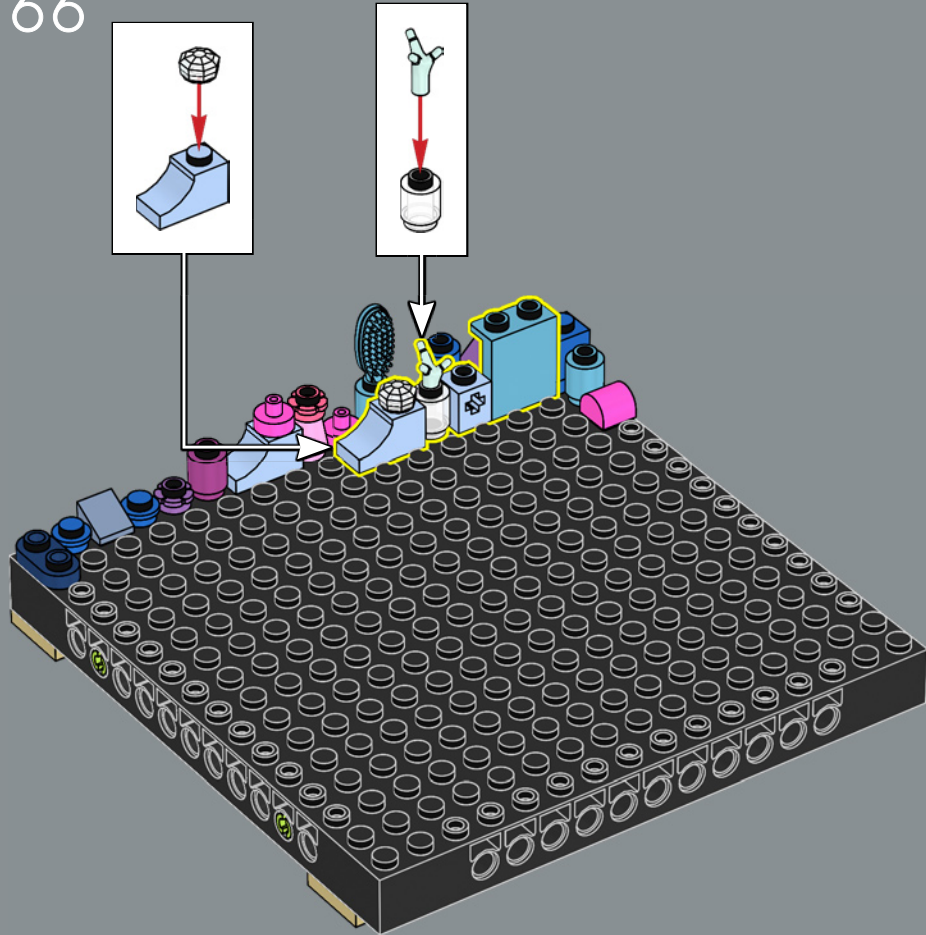

67

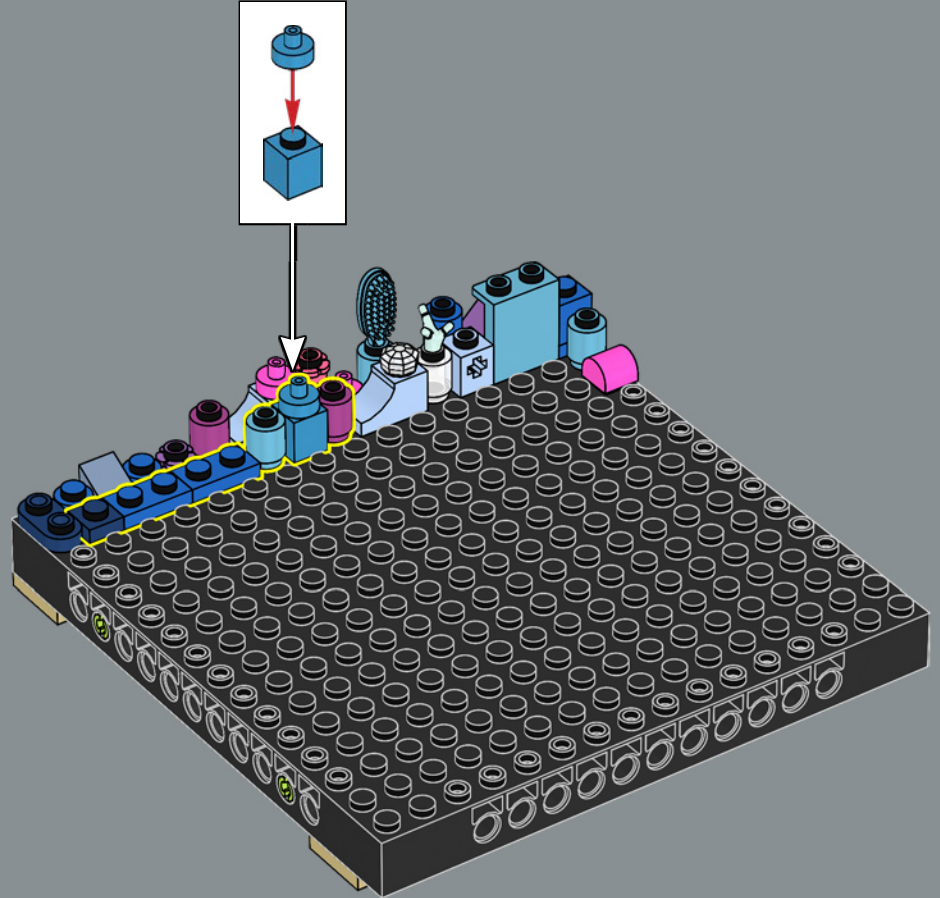

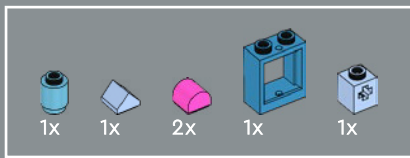

68

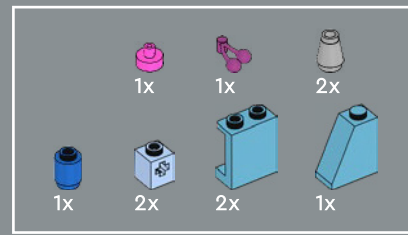
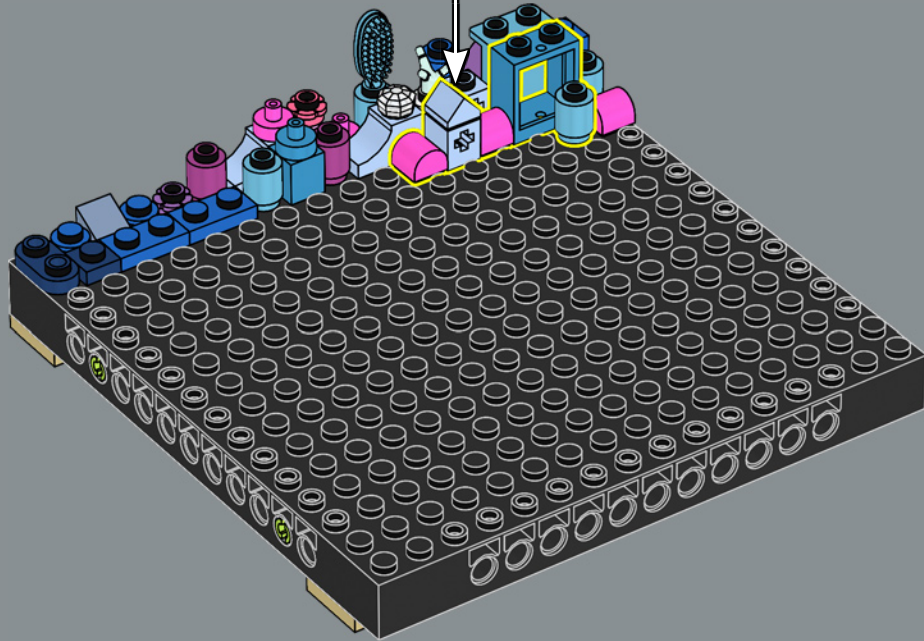
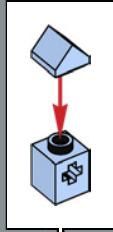

69

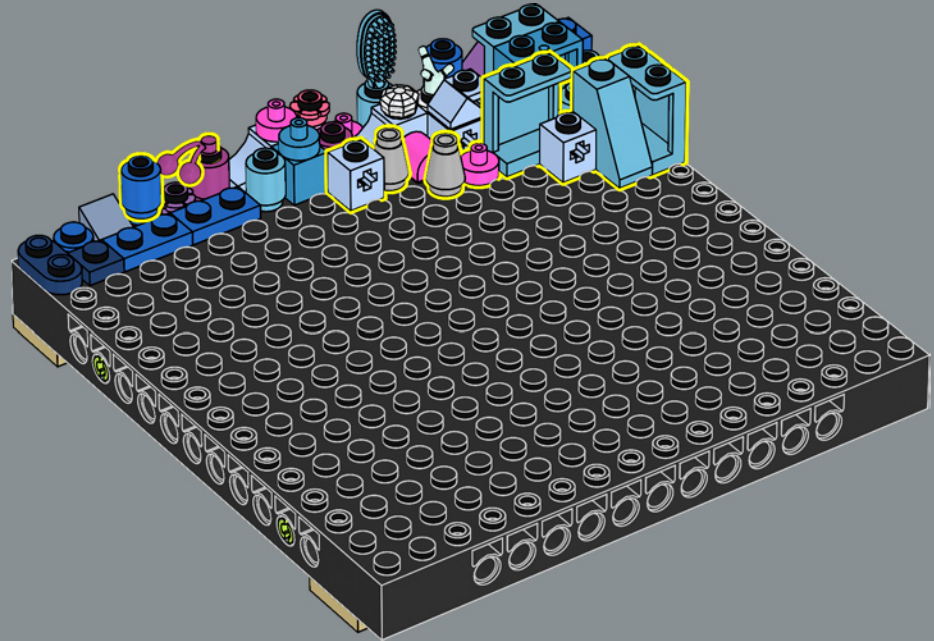

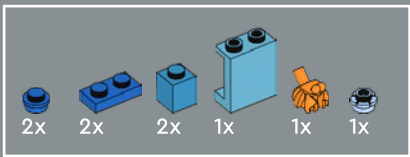

70

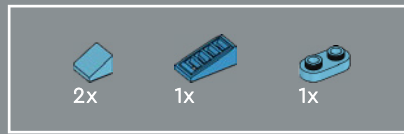
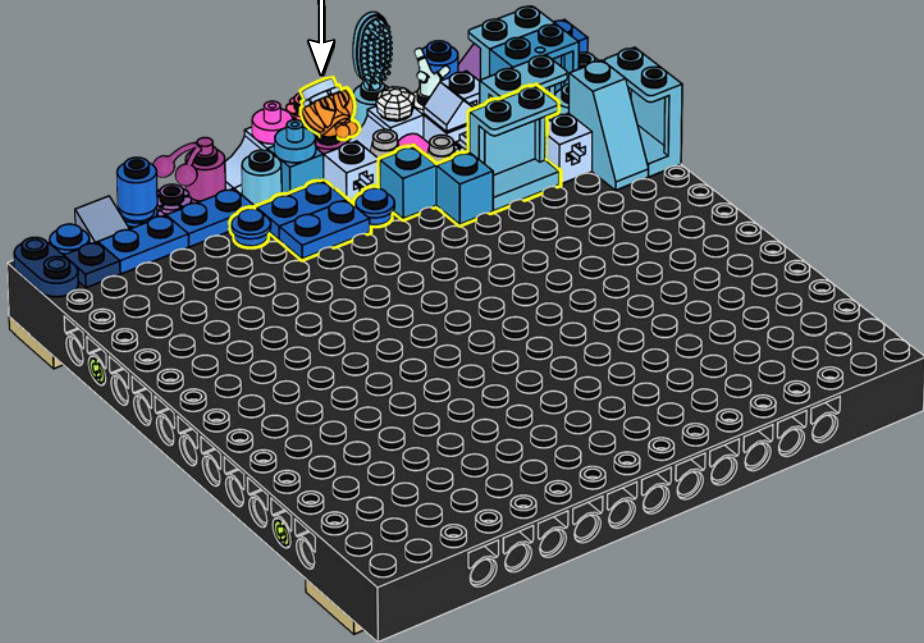
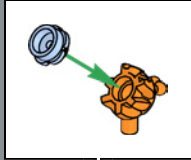

71

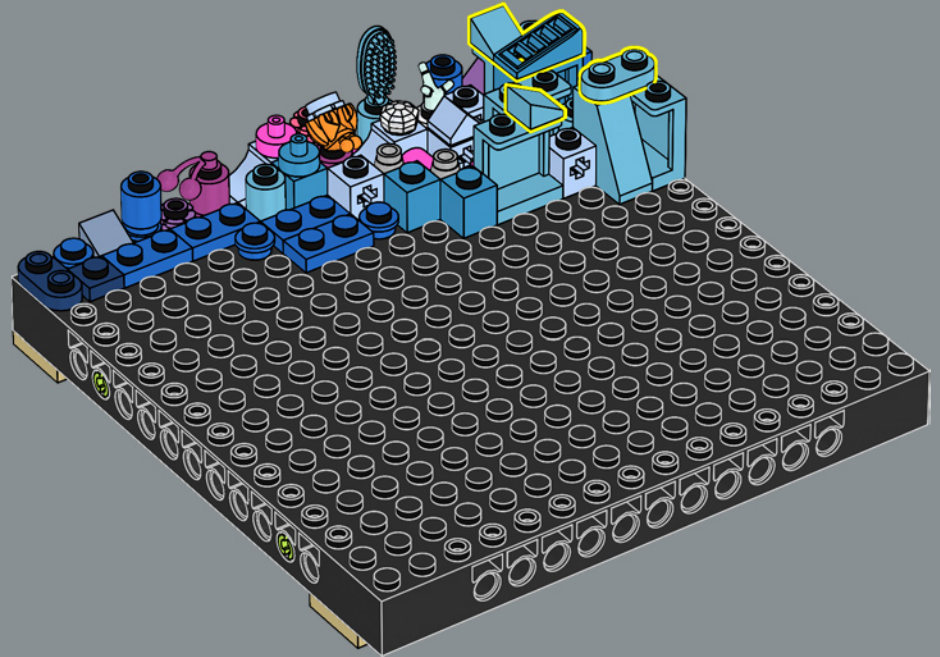

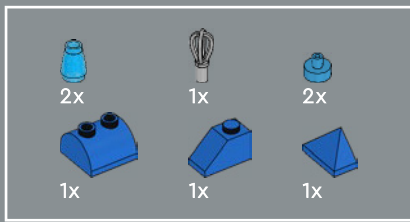

72

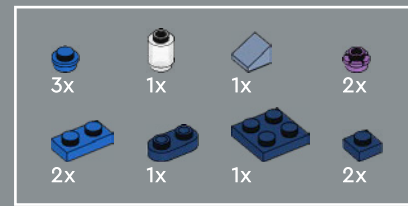
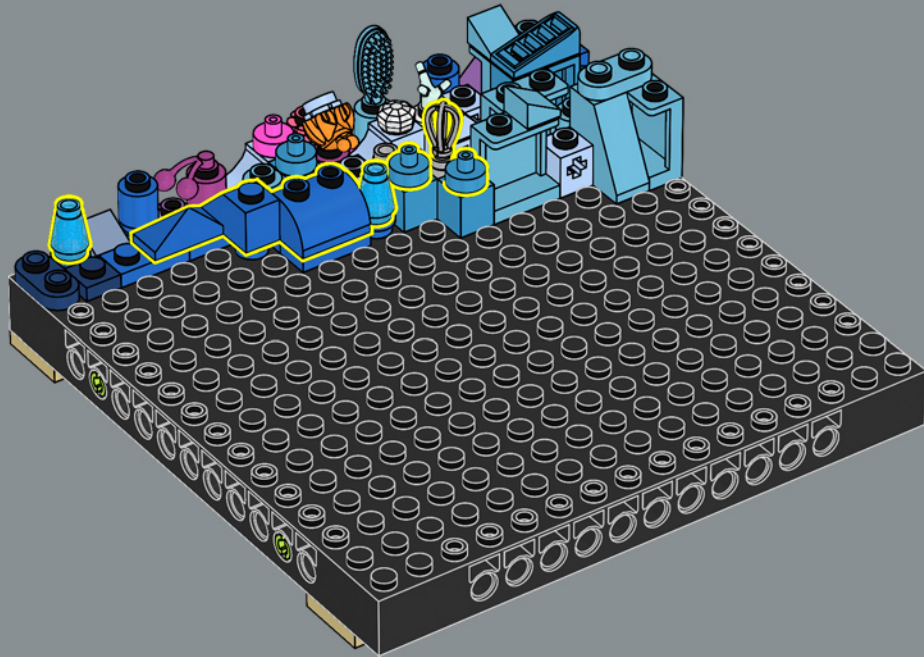

73

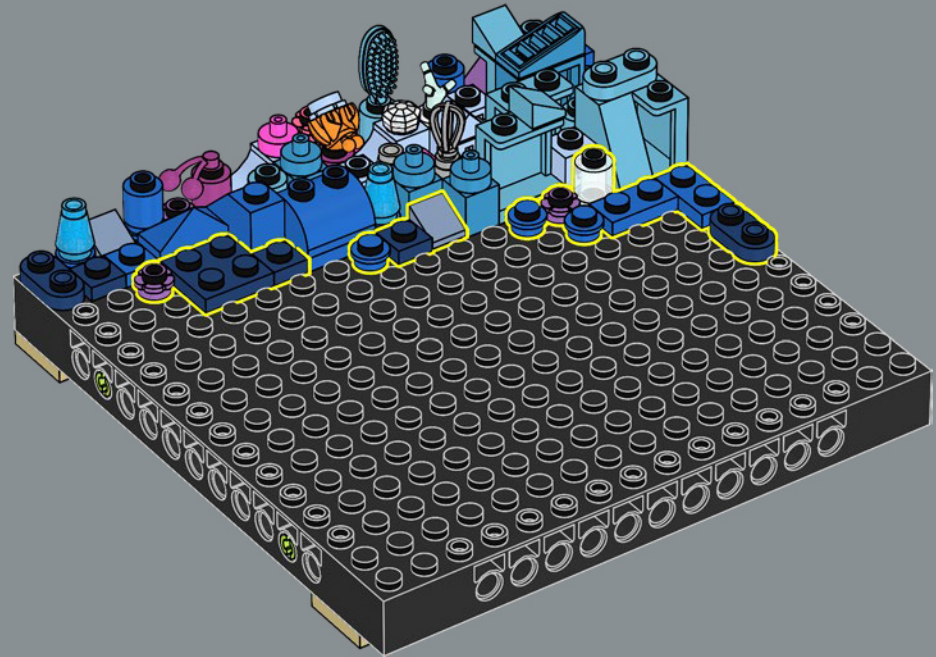

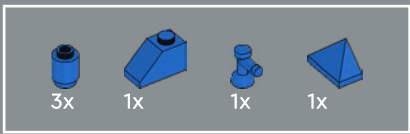

74

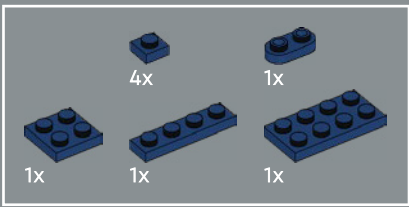
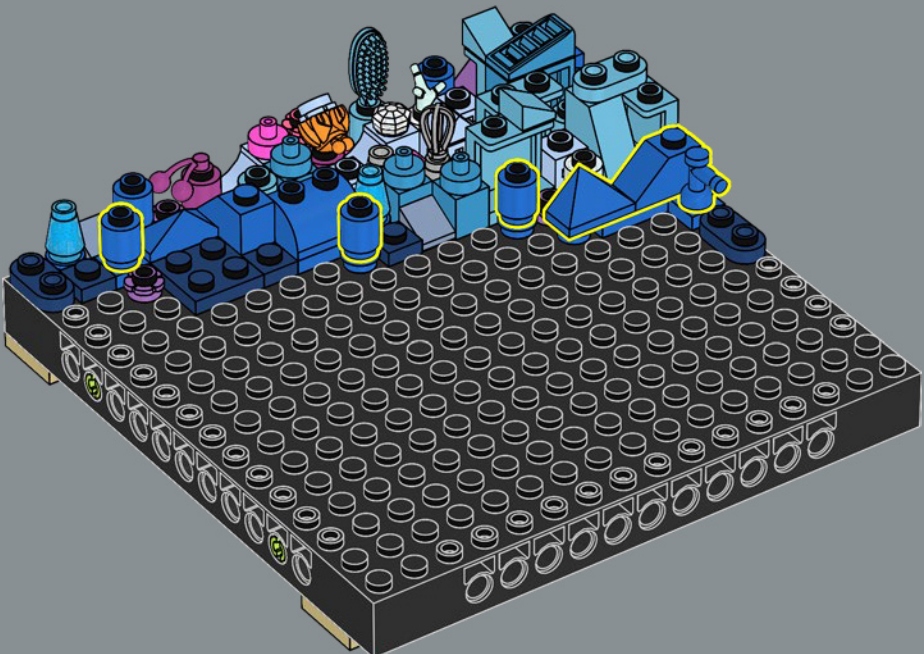

75

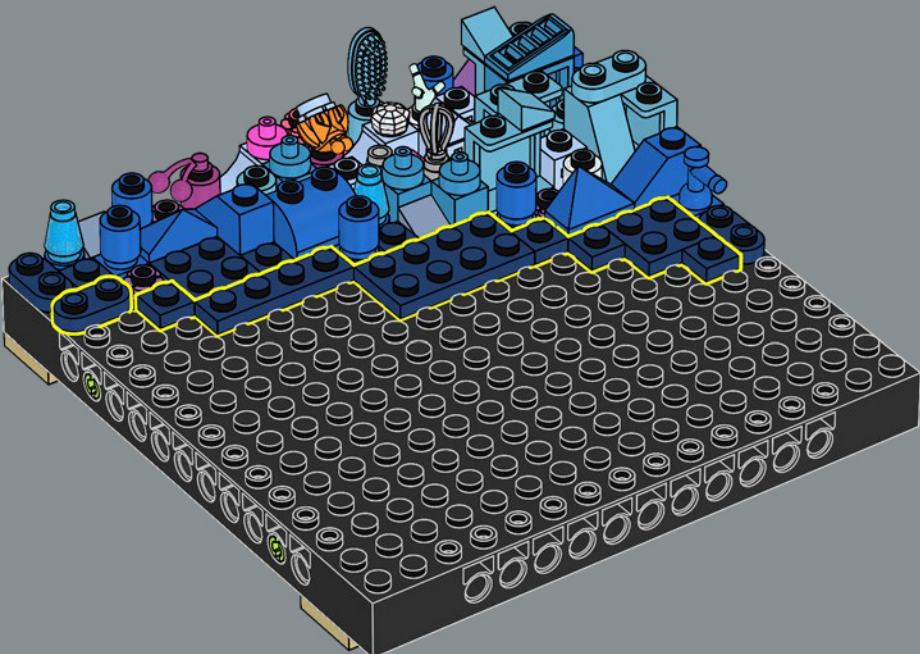

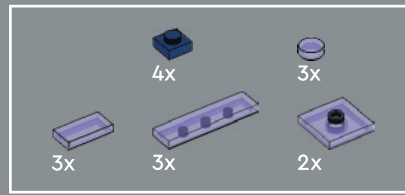

76

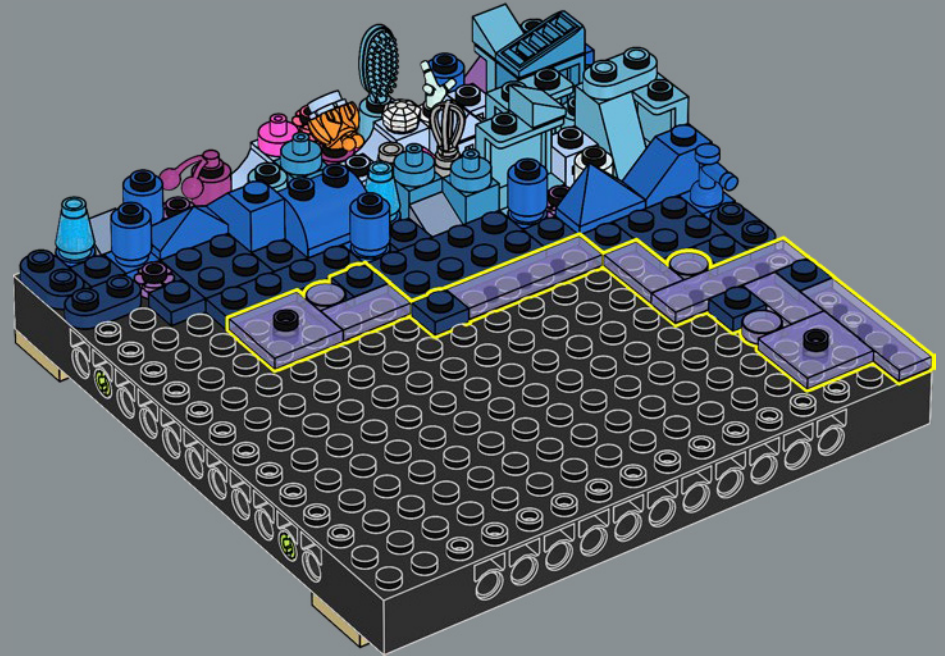

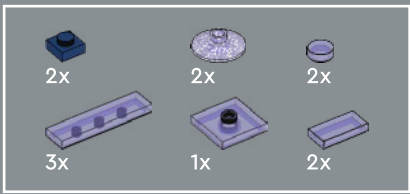

77

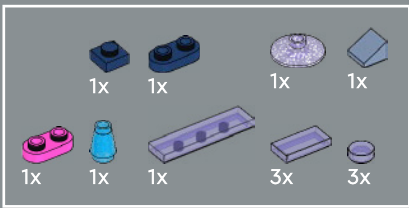
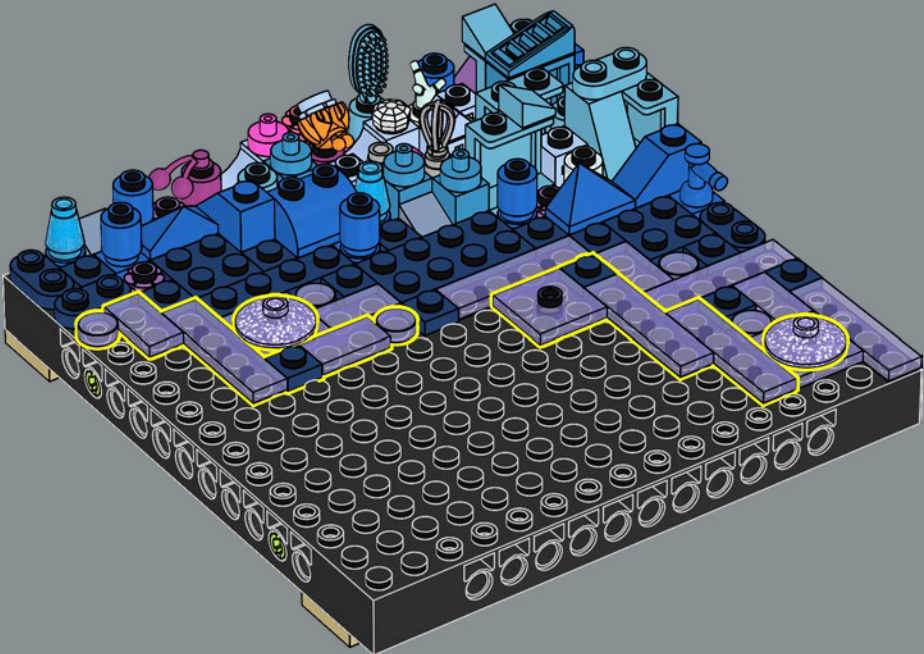

78

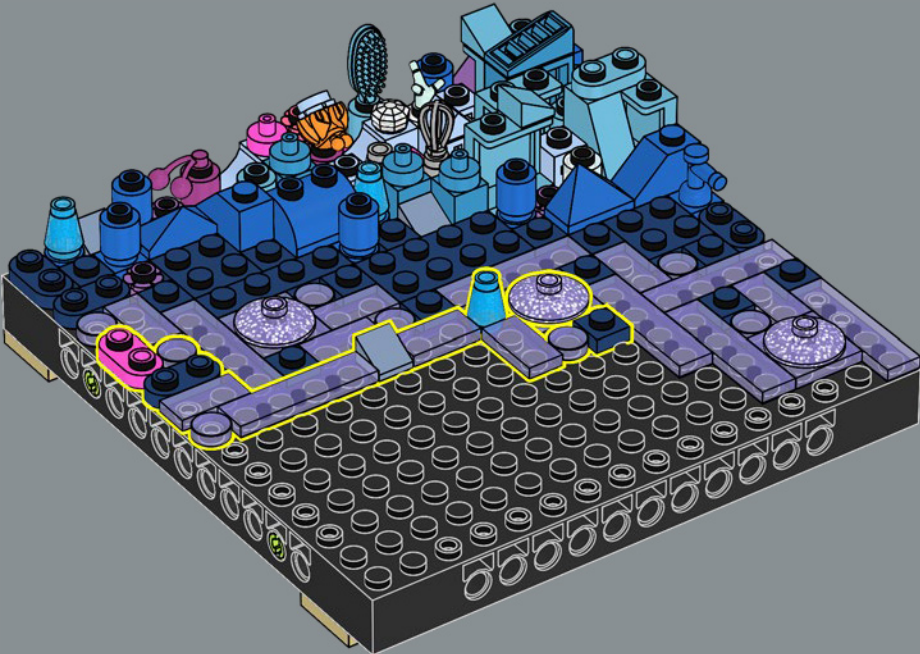

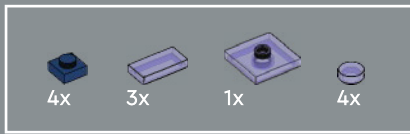

79

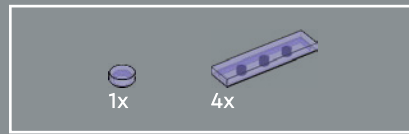
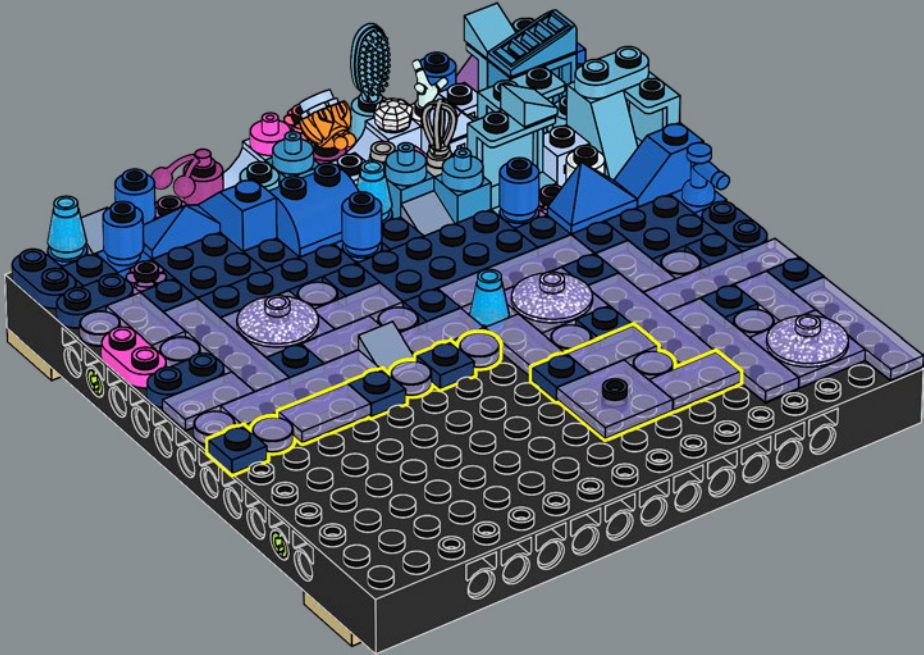

80

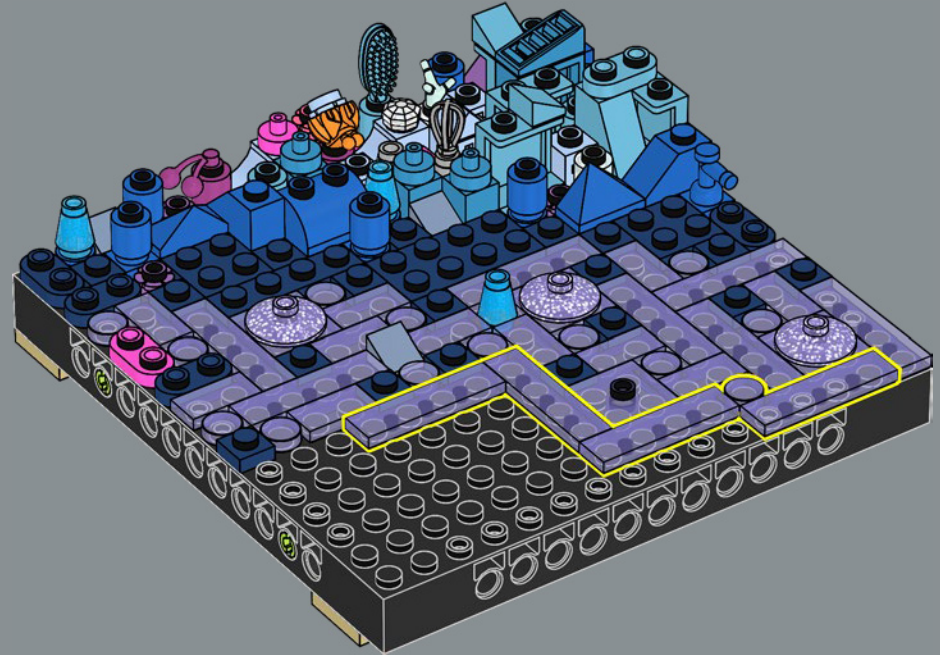

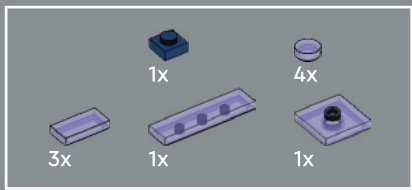

81

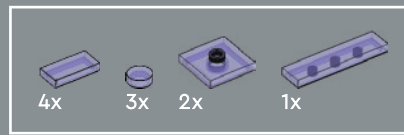
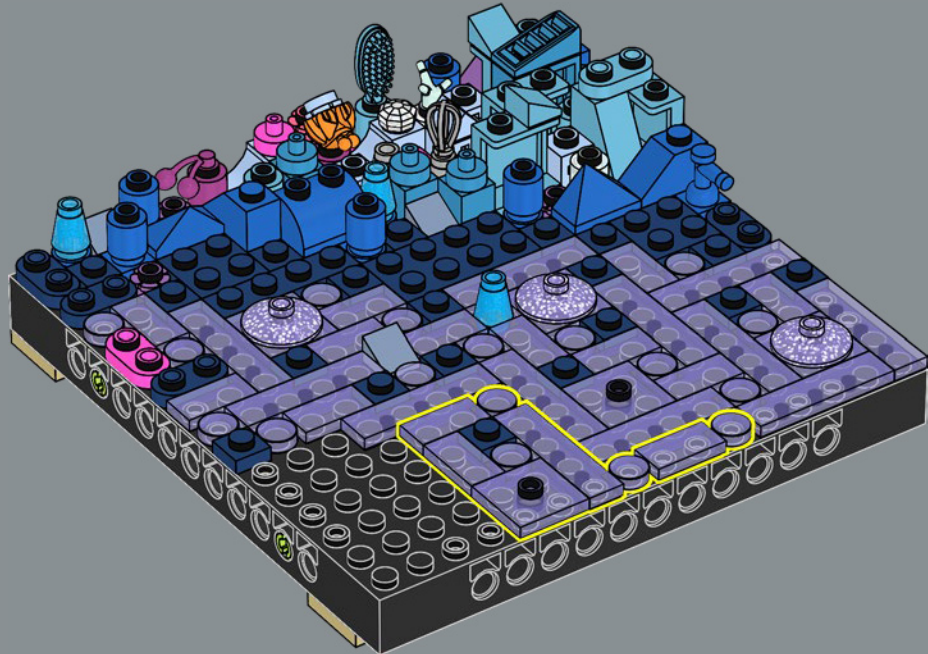

82

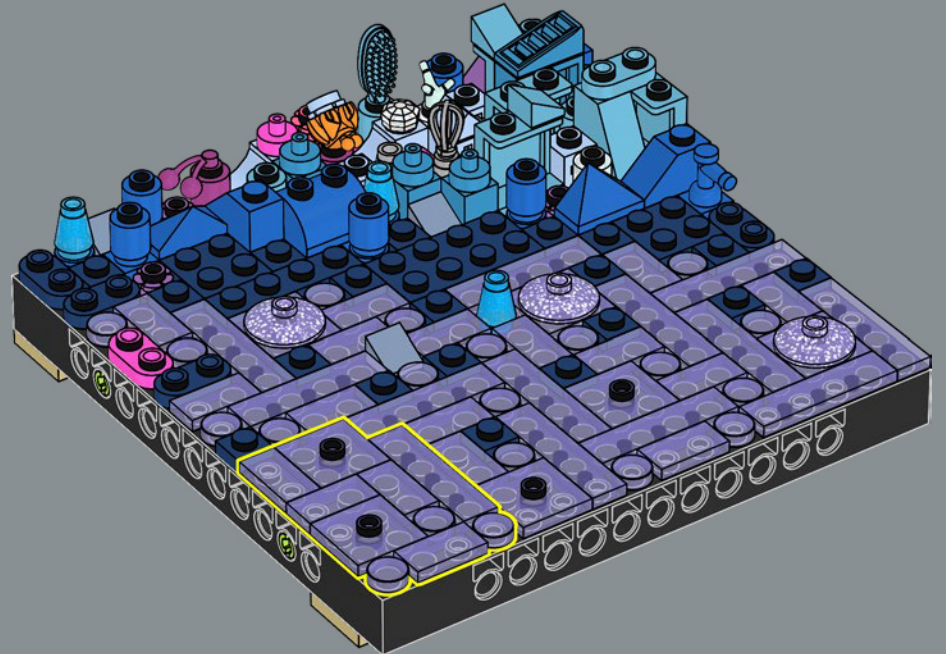

83

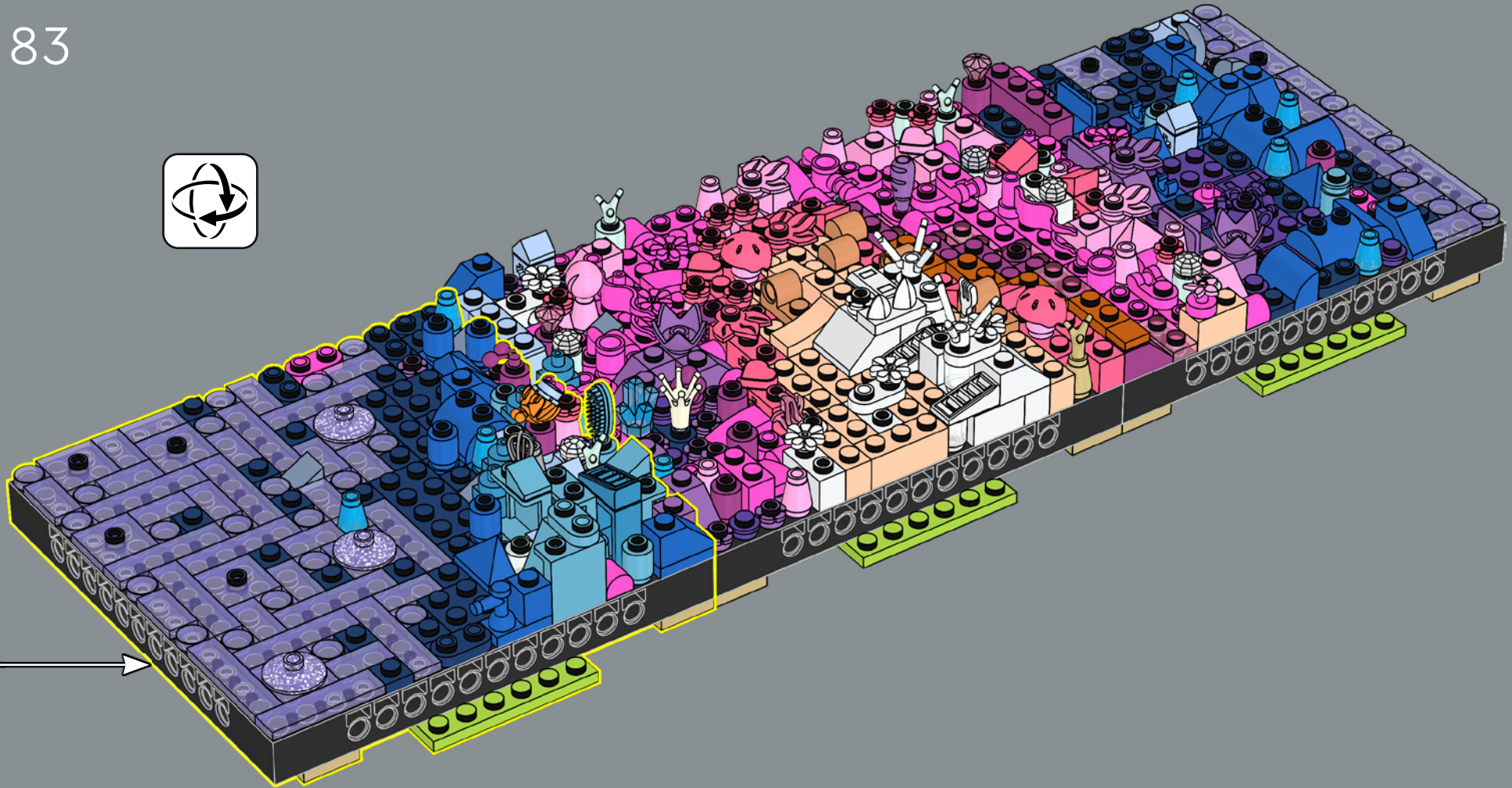

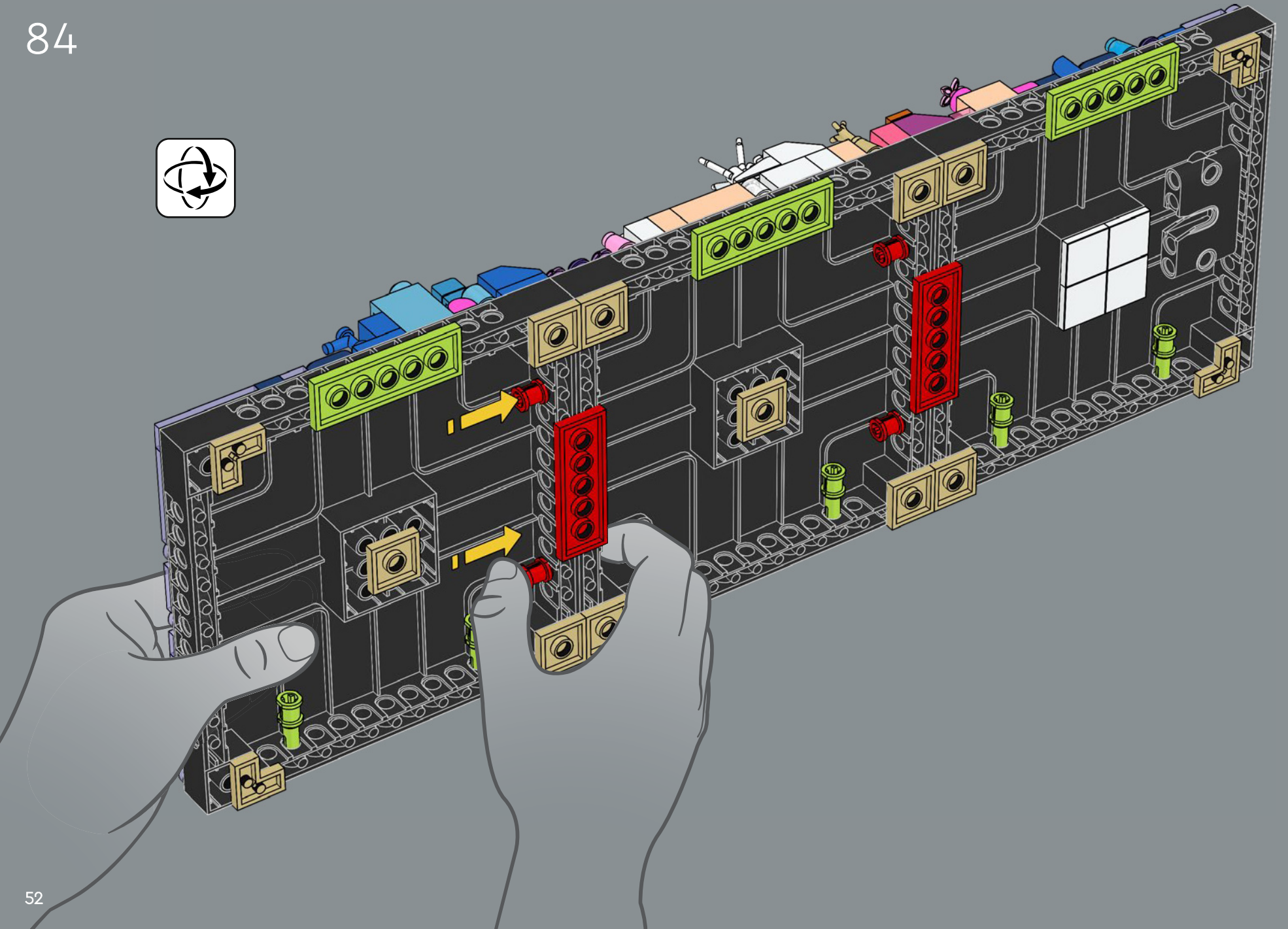

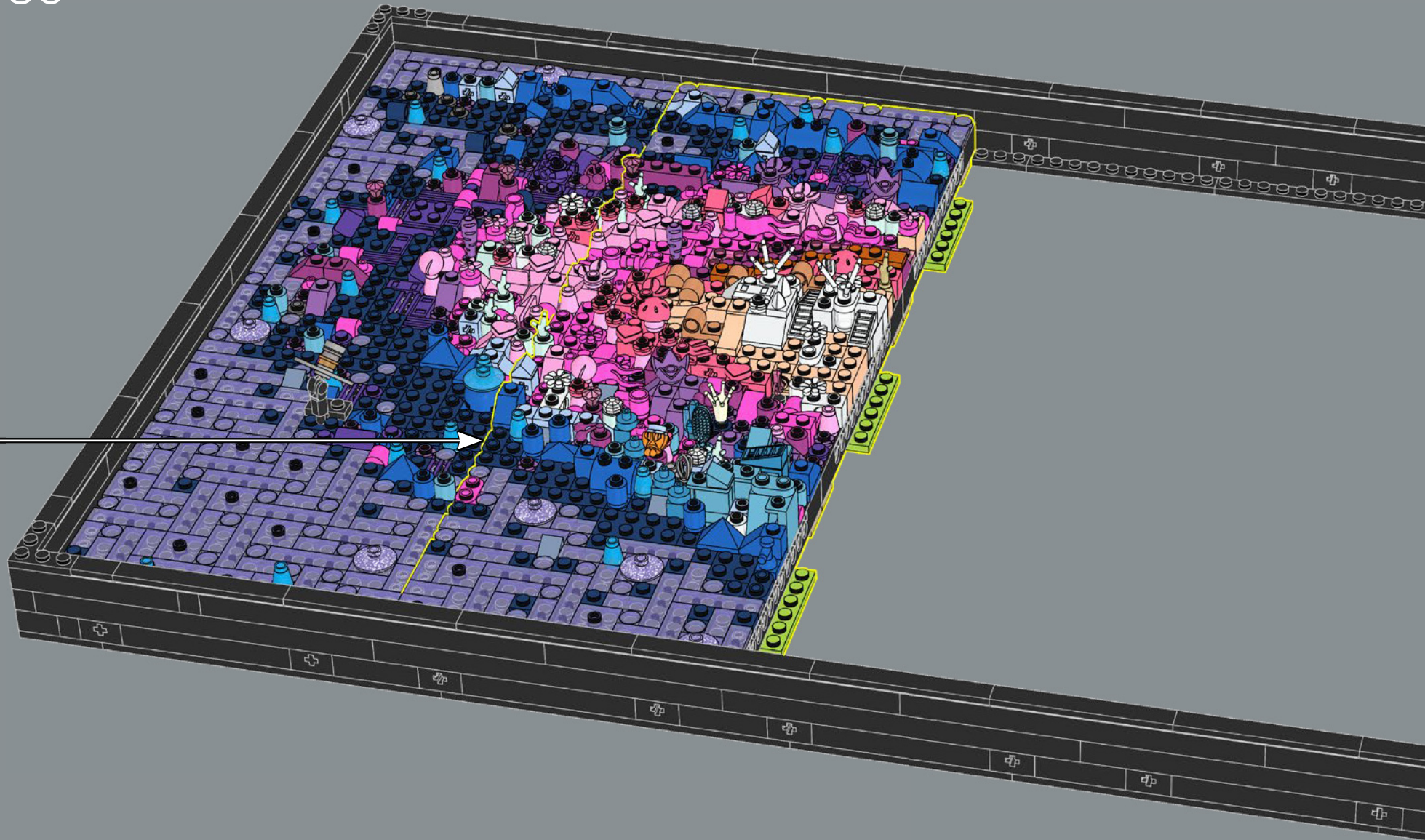



4x

86

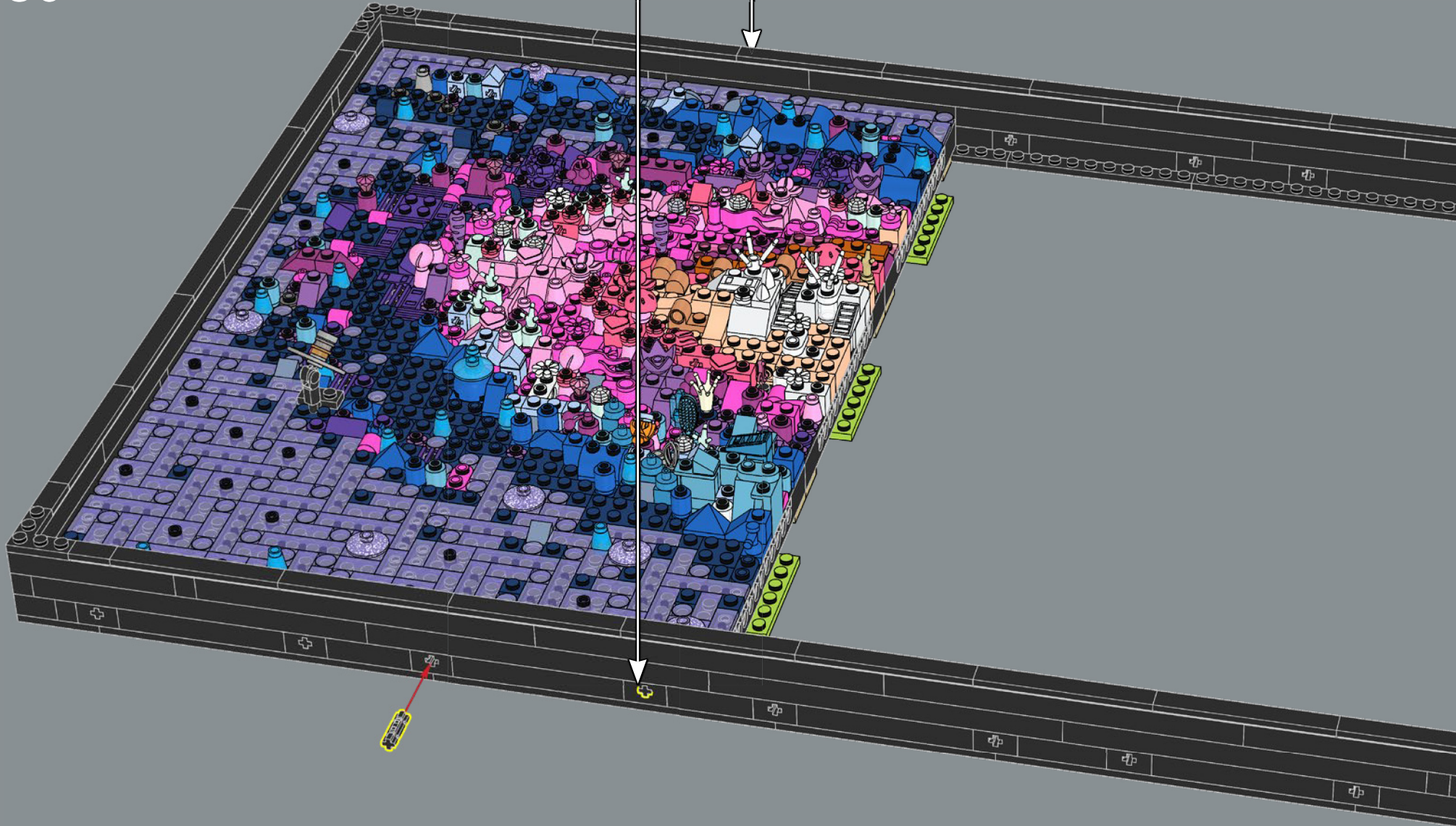

87

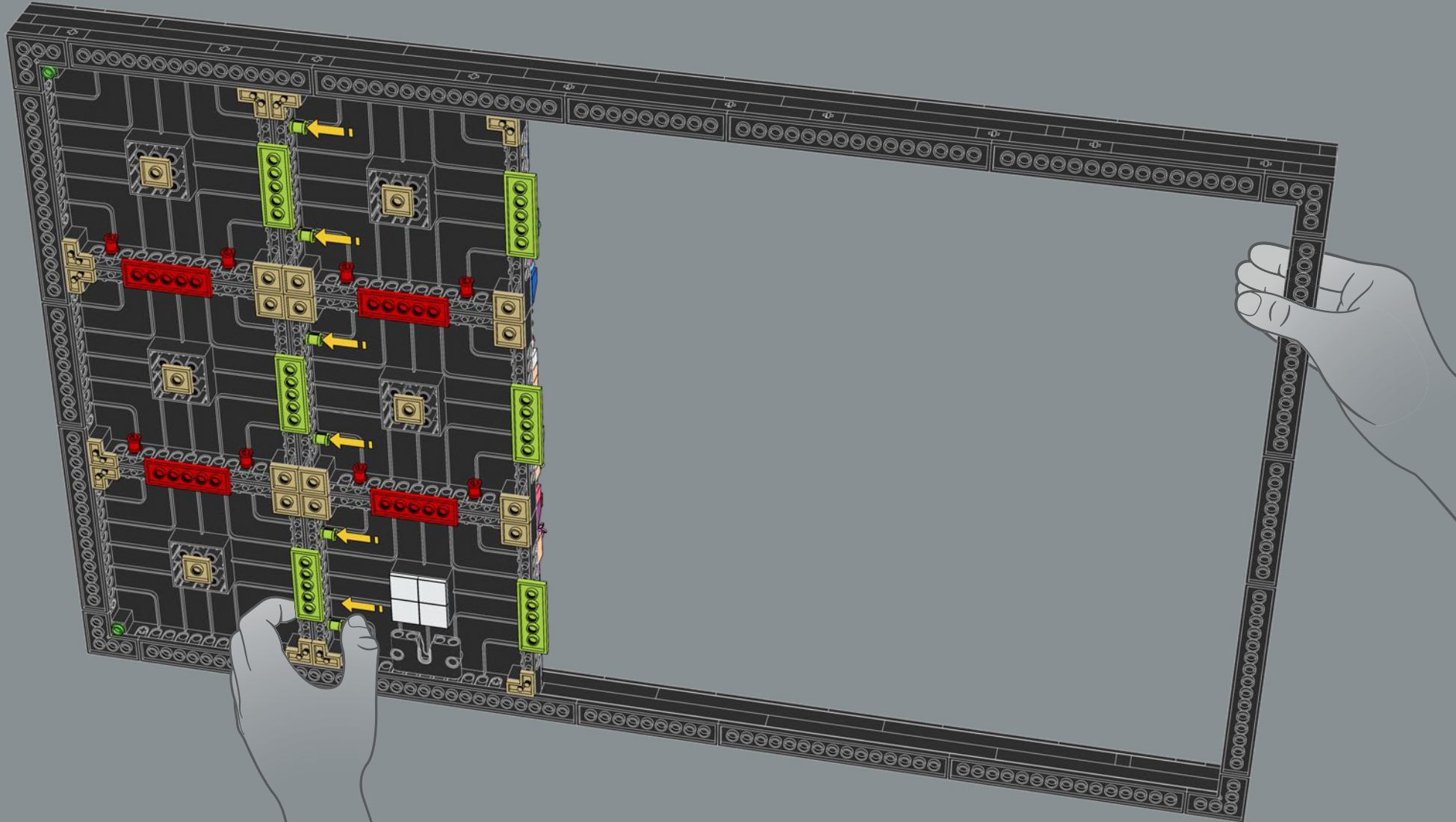



LEGO and the LEGO logo are trademarks of the LEGO Group.
©2024 The LEGO Group. 6517074